



# SM3300 - Interfaces

- INT MOD M/S
- INT MOD SIM
- INT MOD CON
- INT MOD SER
- INT MOD DIG
- INT MOD ANA

## Firmware Update

It is strongly recommended, first to perform a firmware update before further operation.

Download the SM3300 Quick Start Manual for instructions.

## PRODUCT MANUAL

### Firmware version P0153

Contents:

- 1 - Datasheet
- 2 - Safety Instructions
- 3 - Master Slave Interface
- 4 - Simualtion Interface
- 5 - Isolated Contacts
- 6 - Serial interface
- 7 - Digital (User) I/O
- 8 - Isolated Analog Interface

## 2 SAFETY INSTRUCTIONS

### 1 Caution

The following safety precautions must be observed during all phases of operation, service and repair of this equipment. Failure to comply with the safety precautions or warnings in this document violates safety standards of design, manufacture and intended use of this equipment and may impair the built-in protections within. Delta Elektronika shall not be liable for user's failure to comply with these requirements.

### 2 Installation Category

The Delta Elektronika power supplies have been evaluated to installation category II (Over voltage category II).

### 3 Grounding of Mains Input

This product is a safety Class 1 unit. To minimize shock hazard, the unit chassis must be connected to the AC Power Supply mains through a three or four conductor power cable for respectively a single or three phase unit, with the ground wire firmly connected to an electrical ground (safety ground) at the power outlet.

For units designed to be hard-wired to supply mains, the protective earth terminal must be connected to the safety electrical ground before another connection is made. Any interruption of the protective ground conductor, or disconnection of the protective earth terminal will cause a potential shock hazard that might cause personal injury.

### 4 Grounding of Power Output

If the output of a unit is specified to deliver maximum 60VDC, and either the negative or positive power output is grounded, the voltage on the power outputs and sense connections can be considered safe.

**Warning:**

When the positive DC power terminal can exceed 60VDC in respect to the negative DC power terminal, additional external measures must be taken to ensure safety isolation of the DC power terminals and sense connections.

**Warning:**

When the negative power output of the unit can exceed 60VDC / 42.4Vpk in respect to ground, additional external measures must be taken to ensure safety isolation of the DC power terminals and sense connections.

The standard LAN, USB and Interlock connectors and optional interfaces are at ground level and can be considered safe if the negative DC power terminal of the unit does not exceed 1000VDC / 707Vpk in respect to ground.

**Caution 1:** If a low voltage unit has both power outputs floating, or if the output is in series with an external high AC or DC voltage, the negative power output can exceed the safe value in respect to ground as specified in the above warning!

**Caution 2:** Although a high voltage unit is set to a safe voltage below 60VDC, for safety it must always be considered as high voltage unit! Wrong operation, a programming error or an external defect can result in an unsafe high output voltage.

For more information and schematics regards Grounding and Safety, see the special application note "*Safe operation of a power supply*" on the Delta Elektronika website.

### 5 Danger of electrical shock

Touching the contacts of the mains plug or wires directly after disconnecting from the mains can cause an electrical shock. See next paragraph "Connection to the mains supply".

### 6 Connection to mains supply

Either connect to the mains supply permanently or via an industrial type plug, complying with IEC 60309. "Permanently connected equipment" or "Pluggable equipment type B".

### 7 Fuses

Fuses must be changed by authorized Delta Elektronika service personnel only, for continued protection against risk of fire.

### 8 Input Ratings

Do not use an AC Supply which exceeds the input voltage and frequency rating of this unit. The input voltage and frequency rating of the Delta Elektronika power supply series are stated in the accompanying datasheet.

### 9 Live Circuits

Operating personnel must not remove the unit cover. No internal adjustment or component replacement is allowed by non Delta Elektronika qualified personnel. Never replace components with the power cable connected. To avoid injuries, always disconnect power, discharge circuits and remove external voltage sources before touching components.

### 10 Parts Substitutions & Modifications

Parts substitutions and modifications are allowed by authorized Delta Elektronika service personnel only. For repairs or modifications the unit must be returned to a Delta Elektronika service facility.

## 11 Removal of (safety) covers

Safety cover(s) are used to cover potentially hazardous voltages. Observe the following when removing safety cover(s):

- Switch off the unit.
- Disconnect the unit from the mains supply.
- Wait for 3 minutes to allow internal capacitors to discharge.
- Unscrew the screws and remove the cover(s).
- Always place the cover(s) back before connecting the unit to the mains supply again.

## 12 Environmental Conditions

The Delta Elektronika power supplies safety approval applies to the following operating conditions:

- Indoor use
- Ambient temperature : -20 to 50 °C
- Maximum relative humidity : 95%, non condensing, up to 40 °C  
: 75%, non condensing, up to 50 °C
- Altitude : up to 2000 m
- Pollution degree : 2



*Caution risk of electrical Shock*



*Instruction manual symbol. The instrument will be marked with this symbol when it is necessary for the user to refer to the instruction manual*



*Protective ground conductor terminal*



*Off (supply)*



*On (supply)*

## 13 Canada



This product has been tested to the requirements of CAN/CSA-C22.2 No. 61010-1, second edition, including Amendment 1, or a later version of the same standard incorporating the same level of testing requirements

## 14 cTUVus

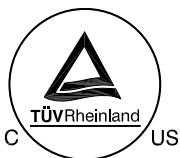

## WEEE (Waste Electrical & Electronic Equipment)

### 1 Correct Disposal of this Product

Applicable in the European Union.



This marking shown on the product, its packing or its literature indicates that it should not be disposed with other wastes at the end of its working life, but should be collected separately to recycle it responsibly to promote the sustainable reuse of material resources.

### 3 MASTER SLAVE INTERFACE

**Warning!** carefully read the chapter "Safety Instructions" in this manual before connecting or operating the unit!

#### 1 CONDENSATION

- During normal operation, humidity will not harm the interfaces, provided the air is not aggressive. The heat normally produced in the power supply will keep it dry.
- Avoid condensation inside the interfaces, break-down could be the result. Condensation can occur during a period the power supply has been switched off (or operating at no load) and the ambient temperature is increasing. Always allow the power supply to dry before switching it on again.

#### 2 TEMPERATURE & COOLING

- The storage temperature range is  $-40$  to  $+85$  °C.
- The operating temperature range is  $-20$  to  $+50$  °C. But this temperature range only holds when the air-intake and air-outlet of the power supply are unobstructed and the temperature of the air-intake is not higher than  $+50$  °C.
- When the power supply is mounted in a cabinet, please note that the temperature of the air-intake should be kept low and avoid a short circuit in the airflow i.e. the hot air leaving the air-outlet entering the air-intake again.
- Please note: a lower temperature extends the life of the interface.

#### 3 FIRMWARE

- Before hardware installation of the interface, check the firmware package is P0153 or higher. In the front menu, go to: SYSTEM INFO -> UNIT-> VERSION.
- If an update is required, refer to the SM3300 unit manual how to do this.

#### 4 HARDWARE INSTALLATION

**Warning!** Never make connections to the Power Input, the Power Output or the Sense Connector when the SM3300 unit is connected to the mains supply!

Safety covers are used to cover these in- and outputs.

##### INSERT INTERFACE IN THE UNIT

- Switch off the unit.
- Disconnect the unit from the mains supply.
- Wait for 3 minutes to allow internal capacitors to discharge.
- Select a none used slot at the rear side.

The Interface can be inserted in any free slot 1...4.  
See figure 3 - 1.

- Unscrew the 2 torx T10 screws and remove the slot cover.
- Insert the interface and place the 2 screws back to secure the interface.

##### CONNECT INTERFACE

- The available connectors on this interface are two 6 pole modular jack connectors, see fig. 3-2.
- Use the cable that has been supplied with the interface to connect the master slave interface.
- Start with the master and connect the cable from the 'OUT' connector to the 'IN' connector of the first slave. Then connect another cable from the 'OUT' connector of the first slave to the 'IN' connector of the next slave. Repeat this until all devices are connected. (see fig 3-2)
- Connect the mains supply again and check all the safety covers are installed.
- Switch on the unit.

#### 5 UNIT CONFIGURATION

- The unit will automatically detect the new inserted interface.
- The interface icon will be shown in the display, see fig 3 - 3.
- Configuring of slaves:
  - - To configure a power supply as a slave, via the front menu go



fig. 3 - 1

All positions are valid for the INT MOD M/S.

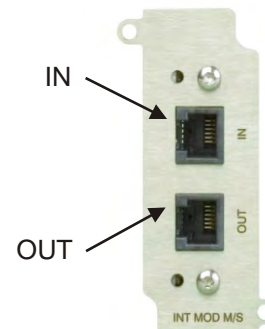

fig. 3 - 2

There are two 6-pole modular jack connectors available on the INT MOD M/S.

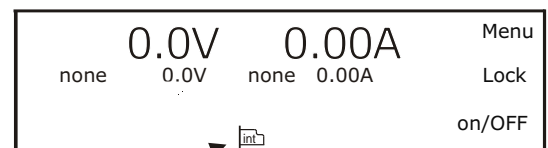

fig 3 - 3

Position of the standard interface icon in the unit display.

to CONFIGURATION -> MASTER SLAVE -> SETTINGS and set the state as slave. Press 'OK' to confirm.

- - The slave icon will be shown in the display, see fig 3 - 4.
- Configuring of the master:
  - - To configure a power supply as the master, via the front menu go to CONFIGURATION -> MASTER SLAVE -> SETTINGS and set the state as master.
  - - In the same menu, enter the number of devices that are connected in series and/or parallel.
    - Press 'OK' to confirm.
  - - The master icon will be shown in the display, see fig 3 - 5.
- The master slave can also be configured via the web interface, or using Ethernet commands.
- After changing master slave settings, stored sequences need to be rebuilt due to system scaling. See the 'Building a Sequence' paragraph in chapter 6.3 of the 'Ethernet & Sequencer Programming Manual' for the SM3300.

## 6 TROUBLE SHOOTING

- Check there is only one master slave interface installed per unit.
- Check there is no simulation interface in each of the units with a master slave interface.
- Check the firmware version as specified in paragraph 3 of this chapter.
- Check the source of the power supply.
- Check the web interface for errors in one of the devices.
- Use Ethernet commands to check for errors in the master slave system.

## 7 CALIBRATION

- Calibration of the interface is not applicable.

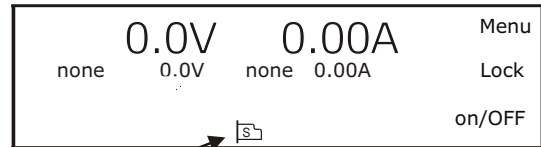

*fig 3 -4  
Position of the interface Slave icon in  
the unit display.*



*fig 3 -5  
Position of the interface Master icon in  
the unit display.*

## 4 SIMULATION INTERFACE

**Warning!** carefully read the chapter "Safety Instructions" in this manual before connecting or operating the unit!

### 1 CONDENSATION

- During normal operation, humidity will not harm the interfaces, provided the air is not aggressive. The heat normally produced in the power supply will keep it dry.
- Avoid condensation inside the interfaces, break-down could be the result. Condensation can occur during a period the power supply has been switched off (or operating at no load) and the ambient temperature is increasing. Always allow the power supply to dry before switching it on again.

### 2 TEMPERATURE & COOLING

- The storage temperature range is  $-40$  to  $+85$  °C.
- The operating temperature range is  $-20$  to  $+50$  °C. But this temperature range only holds when the air-intake and air-outlet of the power supply are unobstructed and the temperature of the air-intake is not higher than  $+50$  °C.
- When the power supply is mounted in a cabinet, please note that the temperature of the air-intake should be kept low and avoid a short circuit in the airflow i.e. the hot air leaving the air-outlet entering the air-intake again.
- Please note: a lower temperature extends the life of the interface.

### 3 FIRMWARE

- Before hardware installation of the interface, check the firmware package is P0153 or higher. In the front menu, go to: SYSTEM INFO -> UNIT-> VERSION.
- If an update is required, refer to the SM3300 unit manual how to do this.
- **Warning!** never update with the simulation interface inside the unit. First remove the interface, do the upgrade and then place the interface back in position.

### 4 HARDWARE INSTALLATION

**Warning!** Never make connections to the Power Input, the Power Output or the Sense Connector when the SM3300 unit is connected to the mains supply!

Safety covers are used to cover these in- and outputs.

#### INSERT INTERFACE IN THE UNIT

- Switch off the unit.
- Disconnect the unit from the mains supply.
- Wait for 3 minutes to allow internal capacitors to discharge.
- Select a none used slot at the rear side.  
The Interface can be inserted in slot 2, 3 or 4. See figure 4 - 1.
- The simulation interface cannot be used in combination with an analog interface or with a master slave interface. Please remove the analog or m/s interface, before using the simulation interface
- Unscrew the 2 torx T10 screws and remove the slot cover.
- Insert the interface and place the 2 screws back to secure the interface.

### 5 UNIT CONFIGURATION

- The unit will automatically detect the new inserted interface.
- The interface icon will be shown in the display, see fig 4 - 2.
- For programming voltage and/or current via the interface, set the correct source for CV and CC respectively, see below example.

For example the interface is assembled in slot2. To program the CV-settings via this interface, via the front menu go to CONFIGURATION -> SOURCE -> Vsettings and set it to Slot2.

To program also the CC-settings via this interface, go to CONFIGURATION -> SOURCE -> Isettings and set it to Slot2.

Instead of doing this via the Front Menu, the source can also be set via the web interface or via Ethernet commands if the unit is

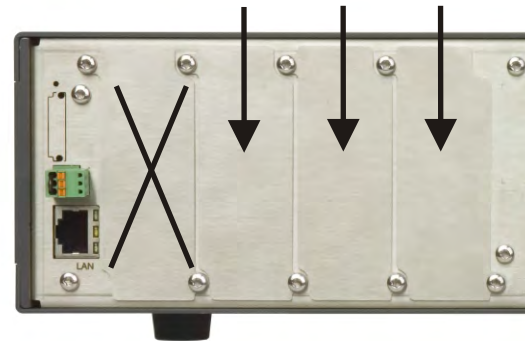

fig. 4 - 1  
Positions for the INT MOD SIM.

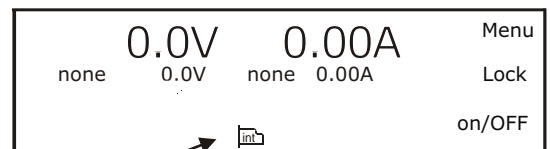

fig. 4 - 2  
Position of the interface icon in the unit display.



connected to the network via LAN.

- To configure the simulation interface, the power supply must be connected to the network via LAN.

## 6 PHOTOVOLTAIC SIMULATION

### CONFIGURATION PARAMETERS

- To simulate a photovoltaic curve some reference parameters are required. These parameters are often specified by manufacturers of photovoltaic panels. The parameters required for the simulation interface should be values under stc. Stc specifies a temperature of 25 °C and an irradiance of 1000 W/m<sup>2</sup> with an air mass 1.5 (am1.5) spectrum.
- Figure 3 - 3 shows an example photovoltaic curve with the relevant parameters names. see table 4-1 for an overview of all reference parameters that are required.
- To simulate a photovoltaic curve based on the reference parameters described above, some panel parameters are required. These parameters are specified in Table 4- 2.

### DYNAMIC EFFICIENCY TEST

- The simulation module can run a dynamic mppt efficiency test as specified in the EN50530 annex B. To run this test extra parameters are required. These parameters are specified in table 4-3.
- The dynamic efficiency test uses the same configuration parameters as described in chapter , but varies the irradiation levels of these parameters specified in Table 4-3.

### TABLE MODE

- The simulation interface also supports a table mode. With this table mode it is possible to simulate a custom curve. Or simulate a photovoltaic curve existing of multiple panels in series where some panels are shaded. In table mode the simulation module uses a table of 128 data points to program the current of the power supply.
- It is possible to calculate a partially shaded photovoltaic curve with the desktop application. The resulting table can be exported to a csv (comma separated value) file.
- Custom or calculated tables are programmable via the desktop application.

### DESKTOP APPLICATION

- All the parameters required for photovoltaic simulation can be configured using the desktop application which is supplied on a CD with the simulation module. The CD can also be downloaded from <http://www.delta-elektronika.nl/>
- When the application is started, it will show the welcome screen, it will query a list of power supplies with a simulation interface installed.
- Select the power supply form the drop down list and connect. Or enter a IP address and connect.
- Select the desired simulation type after this and click start, after which the corresponding application will start.
- Figure 4 - 4 shows the “welcome screen”.
- In the photovoltaic simulation the parameters for the photovoltaic simulation can be configured. The application also renders the photovoltaic curve calculated with the entered values. It reads the voltage and current measurements of the power supply and displays these in the graph. Figure 4 - 5 shows the “Photovoltaic Simulation” application.
- To calculate a new photovoltaic curve, enter all required parameters and click ‘Calculate’. If one of the parameters changes in the window, the calculation will automatically take place.
- The simulation module in the connected power supply stores the parameters in its memory, to get these parameters click ‘Load’. When you accept the following dialog, the parameters from the simulation module are filled in the application.
- To store new parameters in the simulation module, click ‘Write’. The new parameters are now stored in the simulation module.
- The simulation mode can be changed under the Tools section of the menu bar. In the ‘Photovoltaic Simulation’ window these modes are ‘Single Panel’, ‘Multiple Panels’ and ‘Dynamic efficiency’. When the simulation mode is changed, the output of the power supply is switched off.
- In ‘Single Panel’ mode, it is possible to simulate a single photovoltaic curve.

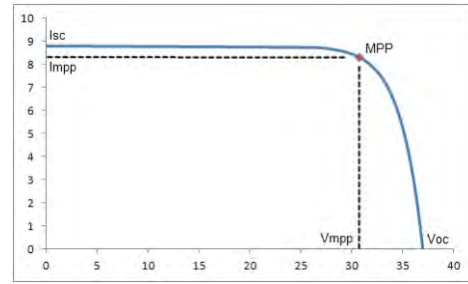

fig. 4 - 3  
PV Curve

Name	Description	Unit
T <sub>stc</sub>	Temperature at STC	°C
G <sub>stc</sub>	Irradiance at STC	W/m <sup>2</sup>
V <sub>mpp,stc</sub>	Maximum Power Point voltage	V
I <sub>mpp,stc</sub>	Maximum Power Point current	A
V <sub>oc,stc</sub>	Open Circuit voltage	V
I <sub>sc,stc</sub>	Short Circuit current	A
T <sub>c (Isc)</sub>	Temperature coefficient for the current, sometimes called alpha	%/°C
T <sub>c (Voc)</sub>	Temperature coefficient for the voltage, sometimes called beta	%/°C

table 4 - 1

Name	Description	Unit
Technology	The type of technology used in the photovoltaic panel, at this moment only polycrystalline (cSi) and Thin Film are supported.	-
T <sub>pv</sub>	The temperature of the photovoltaic panel for the simulation.	°C
G <sub>pv</sub>	The irradiance on the photovoltaic panel for the simulation.	W/m <sup>2</sup>

table 4 - 2

Name	Description	Unit
G <sub>high</sub>	The irradiance at high level	W/m <sup>2</sup>
G <sub>low</sub>	The irradiance at low level	W/m <sup>2</sup>
Start-up time	The initial time for the test to be at low level, this gives the mpp tracker to start up and stabilize.	s
Ramp up	Time taken to ramp up to high intensity	s
Dwell high	The time how long the test must stay at high level	s
Ramp down	Time taken to ramp down to low intensity	s
Dwell low	The time how long the test must stay at low level.	s
Repetitions	The number of repetitions the test must take.	-

table 4 - 3

- In 'Multiple Panel' mode, calculation of an array of panels is possible.
- In 'Dynamic efficiency' mode, it is possible to start a dynamic efficiency test.
- Be sure to store the new reference parameters and dynamic test settings to the simulation module before starting the dynamic efficiency test.

**7 Table simulation**

- The simulation interface can simulate a custom curve based on a table as described in chapter . A separate application is available specifically for this mode.
- With this application it is possible to manage, load and write tables from and to the simulation interface.
- The application can read 'csv' files. To use this feature please use the following format:
  - The columns must be separated by a comma (,).
  - The rows must be separated by a new line.
  - The first row must contain Index, Voltage and Current in that order.
  - The first index must contain zero for either the voltage- or the current settings, where the last index must contain zero for the opposite.
  - The voltage values can only increment or decrement in value for the whole table.
  - See the example in table 4 - 4.

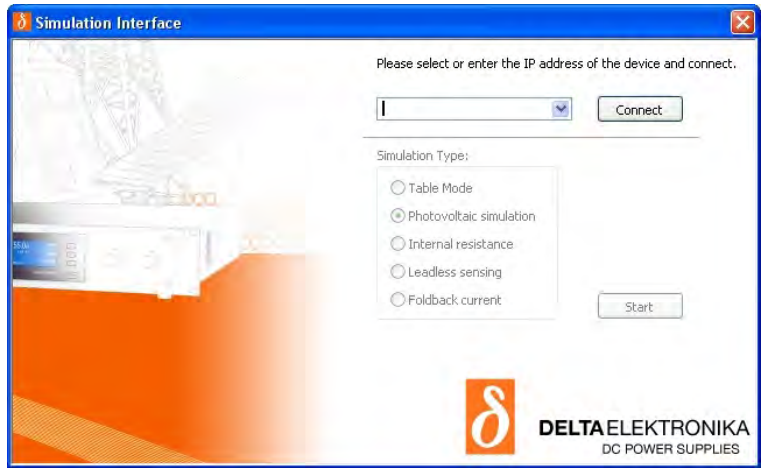

fig. 4 - 4  
Welcome screen

**8 Internal resistance simulation**

- The simulation interface can simulate an internal resistance with a maximum value depending on the type of power supply.
- The settings for the internal resistance can be configured through the web interface. Within the interfaces page.
- The internal resistance simulation is very sensitive to high capacitive loads. A slow setting is available in the web interface if the simulation is unstable.
- The internal resistance simulation is a correction of any other programming source. For example you can set the voltage and current with the front knobs, set an internal resistance value through the web interface, and the simulation interface automatically corrects the output voltage.

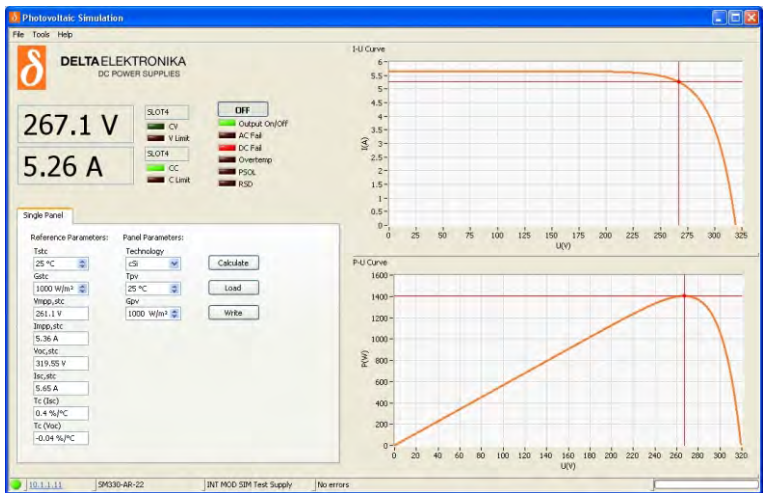

fig. 4 - 5  
Photovoltaic Simulation

**9 Leadless sensing simulation**

- The simulation interface can automatically compensate for voltage drops over the leads without using sense leads. This simulation type has three different modes:
  - Calculate resistance: In this mode the resistance of the cable is calculated by means of the materials electrical resistivity, length and the cross sectional area.
  - Measure voltage drop: In this mode the user must measure the voltage on the output terminals of the power supply, the voltage on the terminals of the load, and the corresponding current.
  - Measure resistance: In this mode the user must measure the resistance of the leads.
- All these operating modes are limited by the maximum configurable resistance as specified.
- The settings for the leadless sensing simulation can be configured through the web interface. Within the interfaces page.
- The leadless sensing simulation is a correction on any other programming source. For example you can set the voltage and current with the front knobs, set a leadless sensing resistance value through the web interface, and the simulation interface automatically corrects the output voltage.

Index,	Voltage,	Current
0,	36.96,	0.000
1,	36.95,	0.069
2,	36.93,	0.139
...		
...		
...		
125,	28.00,	8.661
126,	26.50,	8.731
127,	0.00,	8.800

table 4 - 4



## 10 Foldback current simulation

- The simulation interface can simulate foldback current limiting behavior to provide a higher level of protection for DUT's. After being in constant current mode for a specified time, the power supply will limit the maximum current to a predefined setting. Figure 3 - 6 shows an example of this current limit behavior.
- The foldback current simulation can also be used to simulate a foldforward current limit.

## 11 CALIBRATION

- Calibration of the interface is not applicable.

## 12 TROUBLE SHOOTING

### INTERFACE IS NOT DETECTED

- Check the interface is in slot 2, 3 or 4, not in slot 1.
- Check that there is only one simulation interface installed, and no analog interface.
- Check the firmware version as specified in paragraph 3 of this chapter.

### INTERFACE IS PROGRAMMING ZERO

- Check the power supply programming source is the correct slot.
- Check the simulation interface is in the corresponding simulation type and simulation mode.
- Check the simulation interface configuration. When the simulation type has been changed, all settings are cleared to prevent unpredictable behavior.

### INTERFACE DOES NOT CORRECT THE OUTPUT VOLTAGE OR CURRENT

- Check if the simulation type is enabled.
- Check the simulation interface settings.

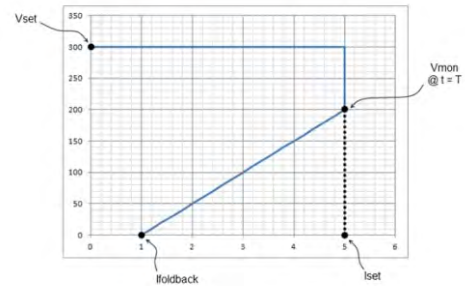

fig. 4 - 6

Example of foldback current limit behavior.

## 5 ISOLATED CONTACTS

**Warning!** carefully read the chapter "Safety Instructions" in this manual before connecting or operating the unit!

### 1 CONDENSATION

- During normal operation, humidity will not harm the interfaces, provided the air is not aggressive. The heat normally produced in the power supply will keep it dry.
- Avoid condensation inside the interfaces, break-down could be the result. Condensation can occur during a period the power supply has been switched off (or operating at no load) and the ambient temperature is increasing. Always allow the power supply to dry before switching it on again.

### 2 TEMPERATURE & COOLING

- The storage temperature range is  $-40$  to  $+85$  °C.
- The operating temperature range is  $-20$  to  $+50$  °C. But this temperature range only holds when the air-intake and air-outlet of the power supply are unobstructed and the temperature of the air-intake is not higher than  $+50$  °C.
- When the power supply is mounted in a cabinet, please note that the temperature of the air-intake should be kept low and avoid a short circuit in the airflow i.e. the hot air leaving the air-outlet entering the air-intake again.
- Please note: a lower temperature extends the life of the interface.

### 3 FIRMWARE

- Before hardware installation of the interface, check the firmware package is P0153 or higher. In the front menu, go to: SYSTEM INFO -> UNIT-> VERSION.
- If an update is required, refer to the SM3300 unit manual how to do this.

### 4 HARDWARE INSTALLATION

**Warning!** Never make connections to the Power Input, the Power Output or the Sense Connector when the SM3300 unit is connected to the mains supply!

Safety covers are used to cover these in- and outputs.

#### INSERT INTERFACE IN THE UNIT

- Switch off the unit.
- Disconnect the unit from the mains supply.
- Wait for 3 minutes to allow internal capacitors to discharge.
- Select a none used slot at the rear side.  
The Interface can be inserted in any free slot 1...4.  
See figure 5 - 1.

- Unscrew the 2 torx T10 screws and remove the slot cover.
- Insert the interface and place the 2 screws back to secure the interface.

#### CONNECT INTERFACE

- The available connectors on this interface are push wire or so-called push in connectors.  
Relay 1 & 2 and relay 3 & 4 via a 6 pole connector.  
Interlock & Enable via a 3 pole connector, see fig. 5 -2.
- Use cables with an internal wiring with a diameter of  $0.3 \dots 0.5\text{mm}^2$  and with a sufficient voltage rating for the voltage of the circuit.
- With regards Safety, the connectors are at the level of Protective Earth.
- Connect the mains supply again and check all the safety covers are installed.
- Switch on the unit.  
The LED indicated in fig. 5-2 will light up.

### 5 UNIT CONFIGURATION

- The unit will automatically detect the new inserted interface.
- The interface icon will be shown in the display, see fig 5 - 3.



fig. 5 - 1

All positions are valid for the INT MOD CON.

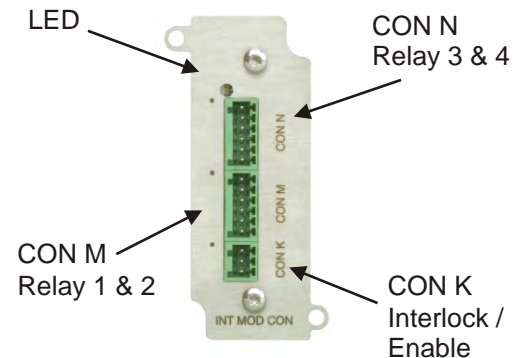

fig. 5 - 2

All four Relay and Interlock/Enable connections are made via push wire or so-called push in connectors.

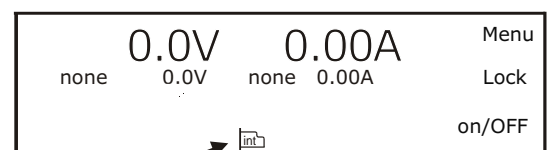

fig 5 -3

Position of the interface icon in the unit display.

## 6 RELAY CONTACTS & INTERLOCK

- This interface provides 4 changeover relay contacts, an Interlock (additional to the standard SM3300 Interlock) and an Enable input. The Relay contacts can be controlled / monitored by Ethernet commands. The Interlock and Enable input can be monitored by Ethernet commands. Refer to section 5.6 for the commands.
- Refer to the Delta Elektronika programming manual for Ethernet (section 5.6) for commands. The manual is stored inside every SM3300 unit and can be downloaded via the web interface. Also can it be downloaded from [www.DeltaPowerSupplies.com](http://www.DeltaPowerSupplies.com).

### RELAY CONTACTS (CON M & CON N)

- Relay contacts are as described below, during power off and when not set. The relay contacts can handle a maximum contact voltage of 60VDC. The maximum continuous current is 2A.

#### Pinning CON M :

- 6 = Relay 1 NC
- 5 = Relay 1 NO
- 4 = Relay 1 Common
- 3 = Relay 2 NC
- 2 = Relay 2 NO
- 1 = Relay 2 Common

#### Pinning CON N :

- 6 = Relay 3 NC
- 5 = Relay 3 NO
- 4 = Relay 3 Common
- 3 = Relay 4 NC
- 2 = Relay 4 NO
- 1 = Relay 4 Common

### INTERLOCK & ENABLE (CON K)

- The Interlock input (pin 1) is initially connected to pin 3 (common). Replace the link by two wires and a switch (for example a cabinet door switch) when its function is required.
- The Enable input (24V, pin 2) impedance is approximately 12kOhm and has a working range of 15V - 30V. Connect the common of the external voltage to pin 3.
- The Interlock and the Enable can not be used simultaneously.
- All interlocks should be valid.

#### Pinning CON K:

- 3 = Common
- 2 = Enable
- 1 = Interlock

## 7 TROUBLE SHOOTING

### INTERLOCK SYMBOL DISPLAYED

- Check the unit's standard interlock connection
- Check Interlock / enable connection on CON K.

## 8 CALIBRATION

- Calibration of the interface is not applicable.

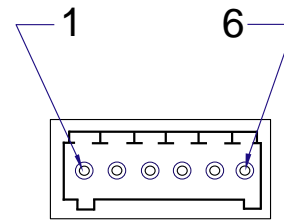

fig. 5 - 4  
Pinning of CON M and N.

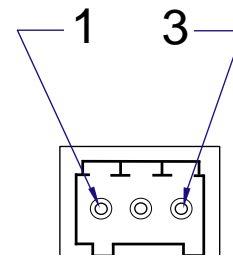

fig. 5 - 5  
Pinning of CON K.

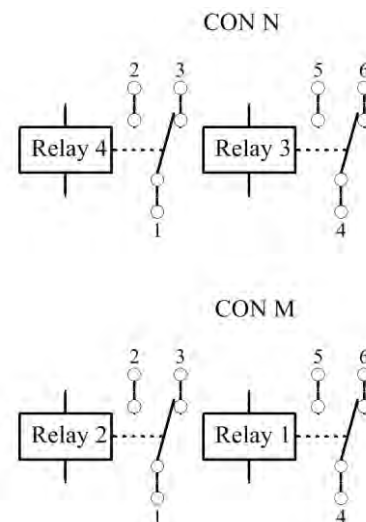

fig. 5 - 6  
Pinning of CON M and N.

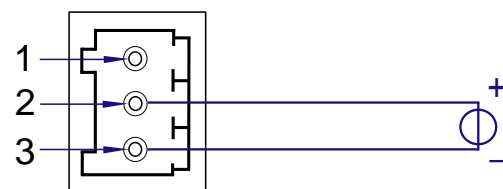

fig. 5 - 7  
15 - 30 V Enable

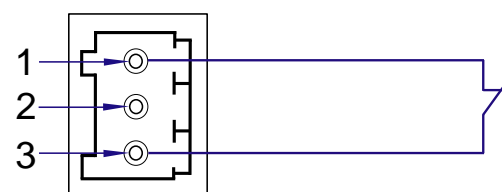

fig. 5 - 8  
Interlock contact (door switch)

## 6 SERIAL INTERFACE

**Warning!** carefully read the chapter "Safety Instructions" in this manual before connecting or operating the unit!

### 1 CONDENSATION

- During normal operation, humidity will not harm the interfaces, provided the air is not aggressive. The heat normally produced in the power supply will keep it dry.
- Avoid condensation inside the interfaces, break-down could be the result. Condensation can occur during a period the power supply has been switched off (or operating at no load) and the ambient temperature is increasing. Always allow the power supply to dry before switching it on again.

### 2 TEMPERATURE & COOLING

- The storage temperature range is  $-40$  to  $+85$  °C.
- The operating temperature range is  $-20$  to  $+50$  °C. But this temperature range only holds when the air-intake and air-outlet of the power supply are unobstructed and the temperature of the air-intake is not higher than  $+50$  °C.
- When the power supply is mounted in a cabinet, please note that the temperature of the air-intake should be kept low and avoid a short circuit in the airflow i.e. the hot air leaving the air-outlet entering the air-intake again.
- Please note: a lower temperature extends the life of the interface.

### 3 FIRMWARE

- Before hardware installation of the interface, check the firmware package is P0153 or higher. In the front menu, go to: SYSTEM INFO -> UNIT-> VERSION.
- If an update is required, refer to the SM3300 unit manual how to do this.
- **Warning!** never update with the serial interface inside the unit. First remove the interface, do the upgrade and then place the interface back in position.

### 4 HARDWARE INSTALLATION

**Warning!** Never make connections to the Power Input, the Power Output or the Sense Connector when the SM3300 unit is connected to the mains supply!

Safety covers are used to cover these in- and outputs.

#### INSERT INTERFACE IN THE UNIT

- Switch off the unit.
- Disconnect the unit from the mains supply.
- Wait for 3 minutes to allow internal capacitors to discharge.
- Select a none used slot at the rear side.  
The Interface can be inserted in any free slot 1...4.  
See figure 6 - 1.
- Unscrew the 2 torx T10 screws and remove the slot cover.
- Insert the interface and place the 2 screws back to secure the interface.

#### CONNECT INTERFACE

- The available connectors on the serial interface are:
  - female 9 pole D-connector for RS232n ( For connection with a PC use a 1:1 cable ( supplied with interface )
  - B-type socket for USB ( cable for connection with PC supplied with interface )
  - push wire or so-called push in connector for RS485 or RS422
- Use cables with an internal wiring with a diameter of  $0.3 \dots 0.5\text{mm}^2$  and with a sufficient voltage rating for the voltage of the circuit.
- With regards Safety, the serial programming connectors are at the level of Protective Earth.
- Connect the cable to the programming source.
- Connect the mains supply again and check all the safety covers are installed.
- Switch on the unit.

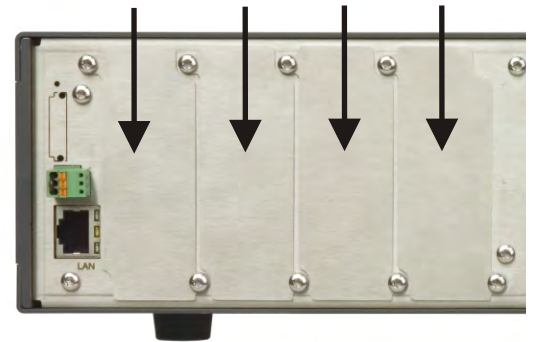

fig. 6 - 1

All positions are valid for the INT MOD SER.

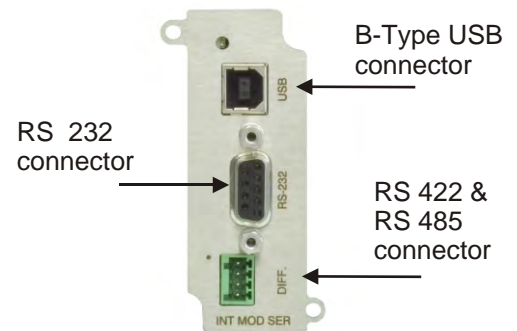
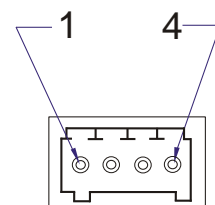

fig. 6 - 2

The available connectors on the INT MOD SER.



1 = Ground  
2 = Positive  
3 = Negative  
4 = x

fig. 6 - 3

Pin connections of the RS422 / RS485 connector.

### 5 UNIT CONFIGURATION

- The unit will automatically detect the new inserted interface.
- The interface icon will be shown in the display, see fig 6 - 4.
- For programming the voltage and/or current via the interface, set the correct source for CV and CC respectively, see below example:

For example the interface is mounted in slot2.  
To program the CV-settings via this interface, via the front menu go to CONFIGURATION -> SOURCE -> Vsettings and set it to Slot2.

To program also the CC-settings via this interface, go to CONFIGURATION -> SOURCE -> Isettings and also set it to Slot2.

Instead of doing this via the Front Menu, the source can also be set via the web interface or via Ethernet commands if the unit is connected to the network via LAN.

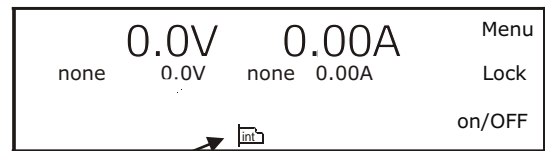

fig 6 -4  
Position of the interface icon in the unit display.

### 6 SERIAL PROGRAMMING

- The unit can be programmed by using the serial programming commands. See table 4.1 for an overview of the available commands.
- To start, first the command "CH n" must be executed to activate the interface by setting its channel number (address). The variable n is a number between 1...32. For example "CH 1".
- The command "CH?" queries the channel of the active serial interface.
- For more details about the commands in table 6.1, refer to chapter 5 of the programming manual for Ethernet & Sequencer. The manual is stored inside every SM3300 unit and can be downloaded via the web interface. It can also be downloaded from www.DeltaPowerSupplies.com.

### 7 PROGRAMMING SPEED

- Programming from a low to a high output voltage is nearly load independent.
- Programming down to a low voltage takes more time on lighter loads. This is caused by the output capacitors, which can only be discharged by the load because the power supply cannot sink current.
- With the optional Power Sink, also the programming down speed is nearly load independent.
- With optional high speed programming, the rise and fall time is 5 to 25 times faster. Note that with this option. the output ripple is higher.

### 8 MONITORING VIA SERIAL INTERFACE

- Via the programming command "MEASURE:" the voltage, current or power can be monitored. See the manual 'Ethernet & Sequencer Programming SM3300' for details.
- **Note:** on a pulsating load, the current and power monitoring will not exactly match the output current and power. This is mainly caused by the current through the output capacitors.

### 9 TROUBLE SHOOTING

- Check the programming source is set to the correct slot.
- Check the output is switched ON, the Interlock is connected and Remote ShutDown is low.
- The first programming command must be "CH n" otherwise the interface will not be activated.
- Check that the communication is working; "\*"IDN?" must return a value. Ensure to end the query with the termination character LF. (LF = 0x0Ah in ASCII)
- Note: the serial interface uses the '.' (dot) as the decimal symbol and not the ',' (comma). Check if your program is using the settings in Microsoft Windows® regional settings.
- Either change your program to specifically use the '.' or else change the decimal symbol to '.' in your regional settings (from the control panel).
- Check that the power supply's output is not limited. Consult the SM3300 manual about adjusting the limit settings.

CH
CH?
*CLS
*IDN?
*RST
MEASURE:VOLTAGE?
MEASURE:CURRENT?
MEASURE:POWER?
OUTPUT?
OUTPUT
SOURCE:VOLTAGE
SOURCE:VOLTAGE?
SOURCE:CURRENT
SOURCE:CURRENT?
SYSTEM:ERROR?
SYSTEM:FRONTPANEL:STATUS
SYSTEM:FRONTPANEL:STATUS?
SYSTEM:FRONTPANEL:CONTROL
SYSTEM:FRONTPANEL:CONTROL?
SYSTEM:PASSWORD:STATUS?
SYSTEM:REMOTE:CV:STATUS
SYSTEM:REMOTE:CV:STATUS?
SYSTEM:REMOTE:CC:STATUS
SYSTEM:REMOTE:CC:STATUS?
SYSTEM:RSD
SYSTEM:RSD:STATUS?
STATUS:REGISTER:A?
STATUS:REGISTER:B?
SOURCE:VOLTAGE:MAX?
SOURCE:CURRENT:MAX?

\*=Clear Error Queue

Table 6.1  
Available serial programming commands



- Check that both values for CV and CC are not zero.  
It is not possible to program a voltage when the current control is set to zero and vice versa.
- Check that the power supply is in the required mode (CV or CC).  
When programming a voltage, the unit must be in CV-mode, when programming a current, the unit must be in CC-mode.

## 10 CALIBRATION

- Calibration of the interface is not applicable.

## 11 Settings

- **Settings via the web page.**

Bustype : USBcom  
Device channel nr : ch 1  
Baudrate : bps 9600  
Data bits : 8  
Stop bits : 1  
Flowcontrol: None  
Parity bits : None  
Slewrate : Disabled  
Termination : Disabled  
Differential communication : Half-duplex

- **Port settings on the PC.**

Baudrate : bps 9600  
Data bits : 8  
Parity bits : None  
Stop bits : 1  
Flow control : None

## 7 DIGITAL (USER) I/O

**Warning!** carefully read the chapter "Safety Instructions" in this manual before connecting or operating the unit!

### 1 CONDENSATION

- During normal operation, humidity will not harm the interfaces, provided the air is not aggressive. The heat normally produced in the power supply will keep it dry.
- Avoid condensation inside the interfaces, break-down could be the result. Condensation can occur during a period the power supply has been switched off (or operating at no load) and the ambient temperature is increasing. Always allow the power supply to dry before switching it on again.

### 2 TEMPERATURE & COOLING

- The storage temperature range is  $-40$  to  $+85$  °C.
- The operating temperature range is  $-20$  to  $+50$  °C. But this temperature range only holds when the air-intake and air-outlet of the power supply are unobstructed and the temperature of the air-intake is not higher than  $+50$  °C.
- When the power supply is mounted in a cabinet, please note that the temperature of the air-intake should be kept low and avoid a short circuit in the airflow i.e. the hot air leaving the air-outlet entering the air-intake again.
- Please note: a lower temperature extends the life of the interface.

### 3 FIRMWARE

- Before hardware installation of the interface, check the firmware package is P0153 or higher. In the front menu, go to: SYSTEM INFO -> UNIT-> VERSION.
- If an update is required, refer to the SM3300 unit manual how to do this.

### 4 HARDWARE INSTALLATION

**Warning!** Never make connections to the Power Input, the Power Output or the Sense Connector when the SM3300 unit is connected to the mains supply!

Safety covers are used to cover these in- and outputs.

#### INSERT INTERFACE IN THE UNIT

- Switch off the unit.
- Disconnect the unit from the mains supply.
- Wait for 3 minutes to allow internal capacitors to discharge.
- Select a none used slot at the rear side.  
The Interface can be inserted in any free slot 1...4.  
See figure 7-1.

- Unscrew the 2 torx T10 screws and remove the slot cover.
- Insert the interface and place the 2 screws back to secure the interface.

#### CONNECT INTERFACE

- The available connectors on the digital user I/O interface are high density 15pole D-connectors, female, see fig. 7-2.
- Use cables with an internal wiring with a diameter of  $0.3 \dots 0.5\text{mm}^2$  and with a sufficient voltage rating for the voltage of the circuit.
- With regards Safety, the user I/O connectors are at the level of Protective Earth.
- Connect the cable to the programming source.
- Connect the mains supply again and check all the safety covers are installed.
- Switch on the unit.
- The LED indicated in fig. 7-2 will light up.

### 5 UNIT CONFIGURATION

- The unit will automatically detect the new inserted interface.
- The interface icon will be shown in the display, see fig 7-3.

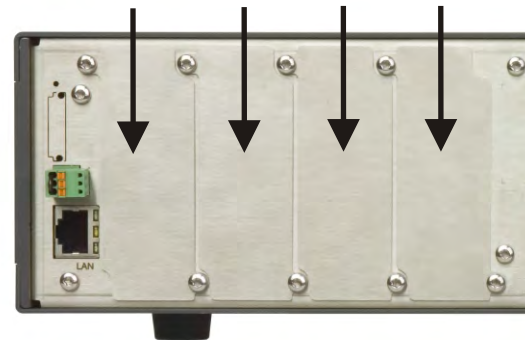

fig. 7 - 1

All positions are valid for the INT MOD DIG.

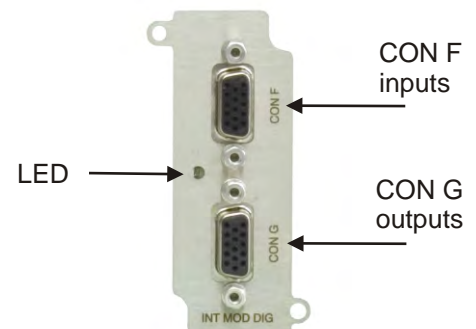

fig. 7 - 2

User Outputs via a 15 pole D-connector .

User Inputs via 15 pole D-connector .

Both connectors are High Density female.

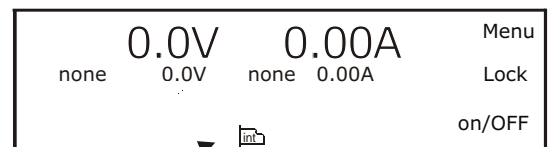

fig 7 - 3

Position of the interface icon in the unit display.

## 6 INPUTS AND OUTPUTS

- This interface provides 8 user inputs and 8 user outputs. These can be controlled / monitored by Ethernet commands or can be used to interact with the Sequencer to make the power supply act like a Power PLC.
- Refer to the Delta Elektronika programming manual for Ethernet (section 5.5) & Sequencer (section 6) for commands. The manual is stored inside every SM3300 unit and can be downloaded via the web interface. Also can it be downloaded from [www.DeltaPowerSupplies.com](http://www.DeltaPowerSupplies.com).

### USER INPUTS (CONNECTOR CON F):

- Unconnected inputs are LOW. To make an input HIGH, apply the +5V of pin 9 or pin 14. Also an external voltage can be used to control the inputs. Make sure the common of the external source is connected to pin 10 or pin 15. The user inputs have a working range of 2V - 30V, use a common zero and have an impedance of approximately 22kOhms. The maximum load of the +5V is 100mA.
- See figure 7-4 and table 7-1 for the pinning of CON F.

### USER OUTPUTS (CONNECTOR CON G):

- The 8 user outputs are Open Drain with common zero. When an output is TRUE, it is pulled down to 0V. Otherwise the output is open. The output impedance is 7 Ohm, maximum rating is 30V / 200mA.
- See figure 7-4 and table 7-2 for the pinning of CON G.

## 7 CALIBRATION

- Calibration of the interface is not applicable.

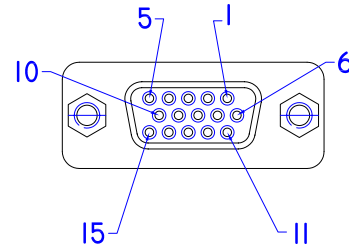

fig. 7 - 4

Pinning of connector CON F and G

1	= user input A
2	= user input B
3	= user input C
4	= user input D
5	= user input E
6	= user input F
7	= user input G
8	= user input H
9	= +5V
10	= 0V
11	= n.c.
12	= n.c.
13	= n.c.
14	= +5V
15	= 0V

Table 7 - 1

Pinning of connector CON F.

1	= user output A
2	= user output B
3	= user output C
4	= user output D
5	= user output E
6	= user output F
7	= user output G
8	= user output H
9	= +5V
10	= 0V
11	= n.c.
12	= n.c.
13	= n.c.
14	= +5V
15	= 0V

Table 7 - 2

Pinning of connector CON G.

## 8 ISOLATED ANALOG INTERFACE

**Warning!** carefully read the chapter "Safety Instructions" in this manual before connecting or operating the unit!

### 1 CONDENSATION

- During normal operation, humidity will not harm the interfaces, provided the air is not aggressive. The heat normally produced in the power supply will keep it dry.
- Avoid condensation inside the interfaces, break-down could be the result. Condensation can occur during a period the power supply has been switched off (or operating at no load) and the ambient temperature is increasing. Always allow the power supply to dry before switching it on again.

### 2 TEMPERATURE & COOLING

- The storage temperature range is  $-40$  to  $+85$  °C.
- The operating temperature range is  $-20$  to  $+50$  °C. But this temperature range only holds when the air-intake and air-outlet of the power supply are unobstructed and the temperature of the air-intake is not higher than  $+50$  °C.
- When the power supply is mounted in a cabinet, please note that the temperature of the air-intake should be kept low and avoid a short circuit in the airflow i.e. the hot air leaving the air-outlet entering the air-intake again.
- Please note: a lower temperature extends the life of the interface.

### 3 FIRMWARE

- Before hardware installation of the interface, check the firmware package is P0153 or higher. In the front menu, go to: SYSTEM INFO -> UNIT-> VERSION.
- If an update is required, refer to the SM3300 unit manual how to do this.

### 4 HARDWARE INSTALLATION

**Warning!** Never make connections to the Power Input, the Power Output or the Sense Connector when the SM3300 unit is connected to the mains supply!

Safety covers are used to cover these in- and outputs.

#### INSERT INTERFACE IN THE UNIT

- Switch off the unit.
- Disconnect the unit from the mains supply.
- Wait for 3 minutes to allow internal circuits to discharge.
- Select a none used slot at the rear side.  
The Analog Interface can only be inserted in slot 2, 3 or 4.  
See figure 8 - 1.
- Unscrew the 2 torx T10 screws and remove the slot cover.
- Insert the interface and place the 2 screws back to secure the interface.

#### CONNECT INTERFACE

- The connector on the analog interface is a female 15pole D-connector.
- Use cables with an internal wiring with a diameter of  $0.3 \dots 0.5\text{mm}^2$  and with a sufficient voltage rating for the voltage of the circuit.
- To avoid hum or noise, the programming cable may have to be twisted in some cases.
- With regards Safety, the analog programming connector is at the level of Protective Earth.
- Connect the cable to the programming source.
- The pinning of the INT MOD ANA is similar to other Delta Elektronika power supplies, see fig 8 - 2.
- Connect the mains supply again and check all the safety covers are installed.
- Switch on the unit.

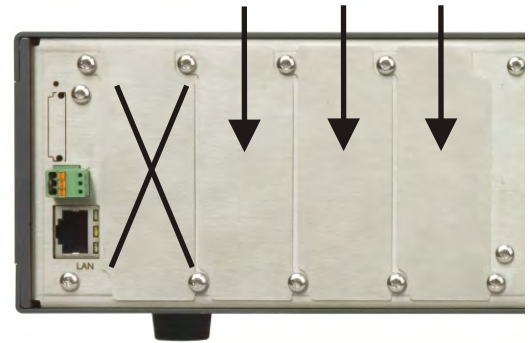

fig. 8 - 1  
Positions for the INT MOD ANA.

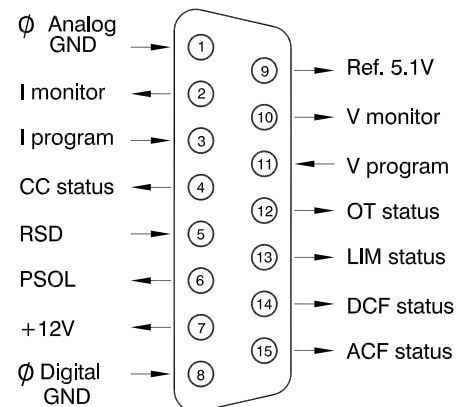

fig. 8 - 2  
Pinning of the 15-pole programming connector.

### 5 UNIT CONFIGURATION

- The unit will automatically detect the new inserted interface.
- The interface icon will be shown in the display, see fig 8 - 3.
- For programming the voltage and/or current via the interface, set the correct source for CV and CC respectively, see below example.

For example the interface is mounted in slot2.  
To program the CV-settings via this interface, via the front menu go to CONFIGURATION -> SOURCE -> Vsettings and set it to Slot2.

To program also the CC-settings via this interface, go to CONFIGURATION -> SOURCE -> Isettings and also set it to Slot2.

Instead of doing this via the Front Menu, the source can also be set via the web interface or via Ethernet commands if the unit is connected to the network via LAN.

### 6 ANALOG PROGRAMMING

- The output voltage and current can be programmed by a voltage in the range of 0 - 5V or 0 - 10V, proportionally to the full output voltage and current. (see fig. 8 - 4).
- The range 0 - 5V or 0 - 10V can be selected by ethernet command only. See ethernet programming manual for further details.
- Both have a protection circuit formed by a series resistor and a parallel zener diode. The capacitor limits the speed to a safe value.
- Note that the programming inputs are floating with regards the power output.
- Turn the output on again with the OUTPUT ON/OFF button.
- To program the unit by current instead of voltage, simply use a parallel resistor as a current to voltage converter. (see fig. 8 - 5).
- The front display will show the programmed values for CV and CC.

### 7 PROGRAMMING SPEED

- Programming from a low to a high output voltage is nearly load independent. See the unit's specifications
- Programming down to a low voltage takes more time on lighter loads. This is caused by the output capacitors, which can only be discharged by the load because the power supply cannot sink current.
- With the optional Power Sink, also the programming down speed is nearly load independent.
- With optional high speed programming, the rise and fall time is 5 to 25 times faster. Note that with this option, the output ripple is higher.

### 8 ANALOG MONITORING

- The monitor outputs give a voltage in the range of 0 - 5V or 0 - 10V, proportional to the output current or voltage. The output current can easily be measured using the I-monitor (see fig. 8 - 6).
- The range 0 - 5V or 0 - 10V can be selected by ethernet command only. See ethernet programming manual for further details.
- Note that the monitor outputs are floating with regards the power output (similar to signals from the ISO AMP).
- The monitor outputs are buffered with op-amp's and protected with series resistors and parallel zenerdiodes.
- The table on page 1 - 2 of the interface datasheet shows the impedance levels of the monitoring outputs.
- The monitoring outputs can drive a meter directly (fig. 8 - 6).
- **Note:** on a pulsating load, the current monitor will not exactly match the output current. This is mainly caused by the current through the output capacitors.

### 9 STATUS SIGNALS

- The status outputs have a separate Ø connection (pin 8) to avoid unwanted offsets in the programming.
- All the status outputs are logic outputs. Logic "0" means the output is 0 V, logic "1" means the output is 5 V. This makes it possible to drive directly: an opto-coupler, a TTL gate or a CMOS gate.
- The Limit Status or LIM-status is "1" in case the output voltage or current reaches the limit setting. Which limit circuit is active can be seen on the front panel indicators.

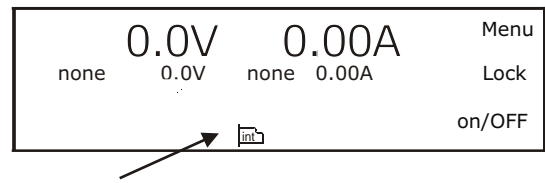

fig. 8 - 3  
Position of the interface icon in the unit display.

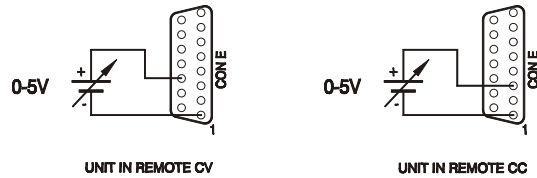

fig. 8 - 4  
Programming by voltage:  
left voltage -, right current programming

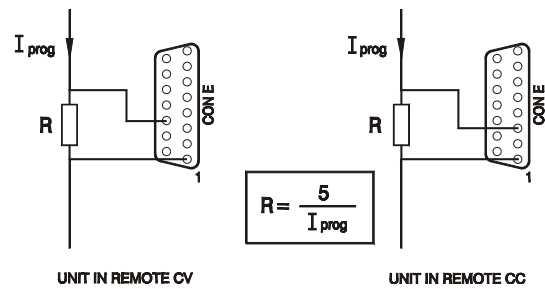

fig. 8 - 5  
Programming by current  
left voltage -, right current programming

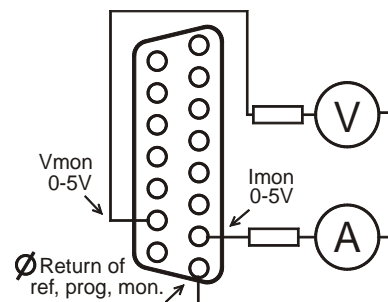

fig. 8 - 6  
Measuring the output voltage and current using the monitoring signals.

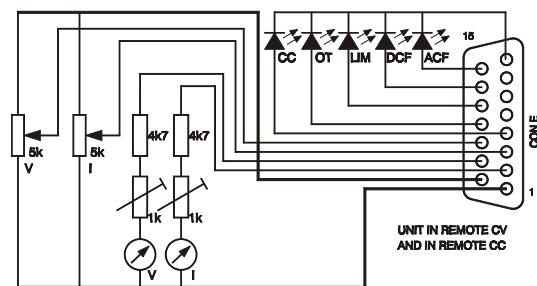

fig. 8 - 7  
Remote control



- The Over Temperature Status or OT status is "1" in case of an over temperature, the display will show the OT symbol and the output shuts down.
- The Current Control Status or CC-status output is "1" when the unit is in CC-mode.
- The Power Sink OverLoad Status or PSOL-status output is "1" when the optional Power Sink is overloaded or overheated.
- The AC-Fail Status or ACF-status output is "1" in case the input voltage is too low or too high.
- The DC-Fail Status or DCF-status output is "1" when the output voltage is either 5% below or above the set point.
- The table on page 1 - 2 of the interface datasheet shows the impedance levels of the status outputs.
- See figure 8 - 7 for a connection diagram.

## 10 REMOTE SHUTDOWN

- A voltage of +4 V...+12 V on the Remote ShutDown input on the programming connector will switch off the output of the unit.
- If the input is high, the RSD icon is shown in the display, see fig 8 - 8.
- It is also possible to use a relay contact or a switch to shut the unit down (see fig. 8 - 9).
- In standby mode the power supply consumes very little power.
- Note: also via Eth or other interfaces RSD can be activated.

## 11 REFERENCE VOLTAGE

- A 5.114V reference voltage is available on the connector. This reference can be used to control the unit with external potentiometers.

## 12 AUXILIARY +12V

- The 12V on the programming connector can be used to supply external circuits. The output current is fuse protected at 0.2A and should not be overloaded.
- Output impedance is 5 Ohms.

## 13 TROUBLE SHOOTING

### PROGRAMMING DOES NOT WORK OK

- Check the interface is in slot2, 3 or 4, not in slot1.
- Check the programming source is the correct slot.
- Check that there is only 1 analog interface installed.
- Check the output is switched ON, the Interlock is connected and Remote ShutDown is low.

### STATUS OUTPUT FAIL

- Check the interface is in slot2, 3 or 4, not in slot1.
- Check the wiring of the analog programming connector for short circuit or loose contacts.
- If the front display shows a status icon, but the logic output on the interface remains low, send the unit back for repair.

## 14 CALIBRATION

- The isolated analog interface is factory calibrated.
- If desired, both the 5 V and 10 V range can be custom calibrated. See the ethernet programming manual for more details.

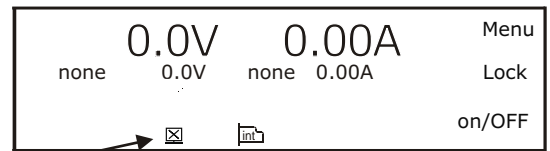

fig. 8 -8

Position of the RSD icon in the unit display.

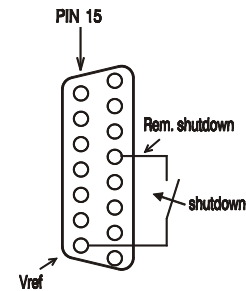

fig. 8 - 9

Remote ShutDown using a relay contact