



SM800 - Power Sink Option

2 Quadrant operation: Source and Sink



SM70-AR-24

Models	Order-Code
SM 7.5-80	Option P245
SM 18-50	Option P246
SM 70-AR-24	Option P247
SM 400-AR-4	Option P248

Order code table

The Power Sink Option permits the power supply to absorb bursts of power fed back to the unit. An internal module senses the status of power supply and sinks current across the output terminals, thus maintaining a constant output voltage.

The Power Sink Option allows a faster response when the power supply is step programmed to a lower voltage at low load conditions.

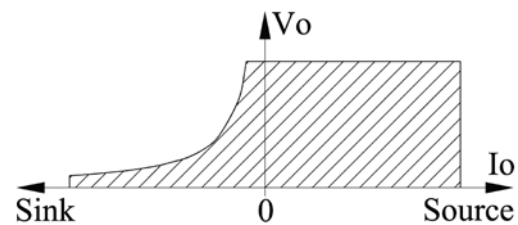

- Can absorb up to 140 W peak power
- Maintains output voltage setting regardless output power is positive or negative (source and sink)
- Ideal solution for supplying electric motors with PWM-speed control. These systems often return power to the power supply during a braking action
- Ideal solution for ATE systems requiring fast down programming at no load conditions
- Generation Automotive waveforms (fast)

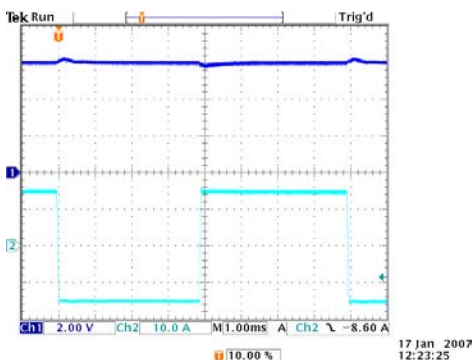

SM18-AR-50 **with** Power Sink Option
Current -15 A means the load delivers 15 A to the power supply (sink operation)

Upper trace: output voltage
Lower trace: output current
(current switching from +15 A to -15 A at $V_o=6$ V)

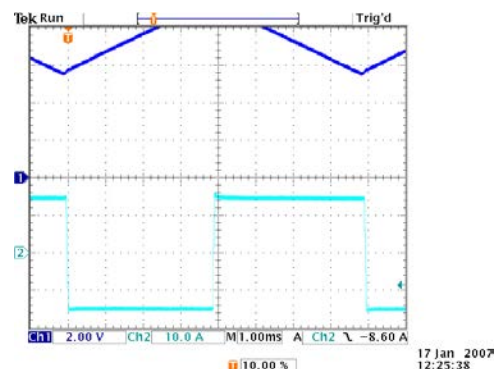

SM18-AR-50 **without** Power Sink Option
The output voltage is out of control when the output current is **negative**

Upper trace: output voltage
Lower trace: output current
(current switching from +15 A to -15 A at $V_o=6$ V)

Power Sink Specifications	SM7.5-80 <i>Option P245</i>	SM18-50 <i>Option P246</i>	SM70-AR-24 <i>Option P247</i>	SM400-AR-4 <i>Option P248</i>
Sink Power Rating max. peak power (electronically limited) max. continuous power ($T_{amb.} = 25\text{ }^{\circ}\text{C}$) max. continuous power ($T_{amb.} = 50\text{ }^{\circ}\text{C}$)	140W 140W 110W			
Max duration Sink Peak Power $P_{sink} = 140\text{ W}, T_{amb.} = 25\text{ }^{\circ}\text{C}$ Duty cycle for use a Peak Power $P_{sink} = 140\text{ W}, T_{amb.} = 25\text{ }^{\circ}\text{C}$	Continuous 100%			
Max Sink Current ($V_0 \geq 2\text{ V}$ and $P \leq 140\text{ W}$)	Limited at 36 A	Limited at 36 A	Limited at 25 A	Limited at 5 A
Protection	Electronic Power Limit limits the current. The temperature of the power sink is fan controlled, and the circuit shuts down in case of thermal overload.			
Recovery time / Deviation $V_0 = 6\text{ V}, I_0: +30\text{ A} \rightarrow -10\text{ A}$ recovery within 100 mV / deviation: $V_0 = 15\text{ V}, I_0: +20\text{ A} \rightarrow -4\text{ A}$ recovery within 100 mV / deviation: $V_0 = 24\text{ V}, I_0: +15\text{ A} \rightarrow -2\text{ A}$ recovery within 100 mV / deviation: $V_0 = 60\text{ V}, I_0: +9\text{ A} \rightarrow -1\text{ A}$ recovery within 100 mV / deviation: $V_0 = 150\text{ V}, I_0: +3\text{ A} \rightarrow -0.5\text{ A}$ recovery within 1 V / deviation: $V_0 = 350\text{ V}, I_0: +1\text{ A} \rightarrow -0.1\text{ A}$ recovery within 1 V / deviation: <i>(load current switches from positive to negative)</i>	$di/dt = -0.7\text{ A}/\mu\text{s}$ 200 μs / 0.15 V - - - - - - <i>note: values are typical</i>	$di/dt = -0.7\text{ A}/\mu\text{s}$ 400 μs / 0.25 V $di/dt = -0.5\text{ A}/\mu\text{s}$ 700 μs / 0.20 V - - - - <i>note: values are typical</i>	- $di/dt = -0.5\text{ A}/\mu\text{s}$ 700 μs / 0.85 V $di/dt = -0.4\text{ A}/\mu\text{s}$ 800 μs / 0.75 V $di/dt = -0.3\text{ A}/\mu\text{s}$ 4ms / 0.65 V - - <i>note: values are typical</i>	- - - $di/dt = -0.1\text{ A}/\mu\text{s}$ 800 μs / 4.0 V $di/dt = -0.05\text{ A}/\mu\text{s}$ 2.0ms / 2.7 V <i>note: values are typical</i>
Programming Down Speed Fall time at no load (90 – 10%) Fall time at no load <i>without Power Sink</i> Unit with Hi Speed Programming Option Fall time at no load (90 – 10%) Fall time at no load <i>without Power Sink</i>	(7.5 → 0 V) 6.5ms 5s P245 + P250 120 μs 65ms	(18 → 0 V) 17ms 6s P246 + P251 390 μs 210ms	(70 → 0 V) 25ms 4s P247 + P252 1ms 760ms	(400 → 0 V) 19ms 4.5s P248 + P253 <i>Not possible.</i>
Parallel and Series operation Refer to power sink manual for details and restrictions.	Using multiple units in parallel operation, only one unit can have a power sink. Using multiple units in series operation, all units must have a power sink.			

Notes: - The maximum sink current at higher voltages will not be the maximum specified current due to the power limit. For example, at 30V, the max sink current will be 4.7 A ($30\text{ V} \times 4.7\text{ A} = 140\text{ W} = \text{max power}$).
- A higher sink current than the maximum current will cause the output voltage to rise.

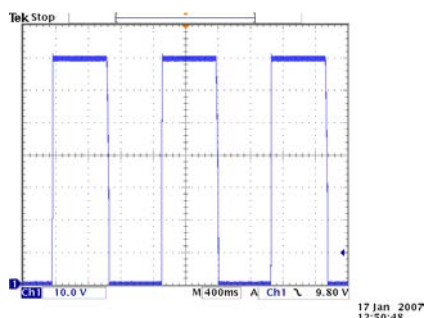

SM70-AR-24 with Power Sink Option
fast discharge of output capacitors by Power Sink circuit

Trace: output voltage
Voltage Programming Speed at NO LOAD

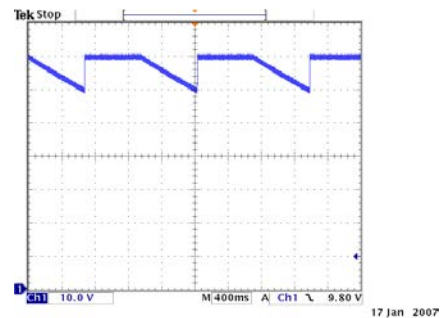

SM70-AR-24 without Power Sink Option
slow response time during voltage step down, time needed to discharge the output capacitors

Trace: output voltage
Voltage Programming Speed at NO LOAD

USER MANUAL

Setting up the Power Sink

On the pc board P642, two jumpers are located.

With these jumpers the Power Sink can be set up for different operation.

Inside the power supply, P642 can be found in the section behind the front panel.

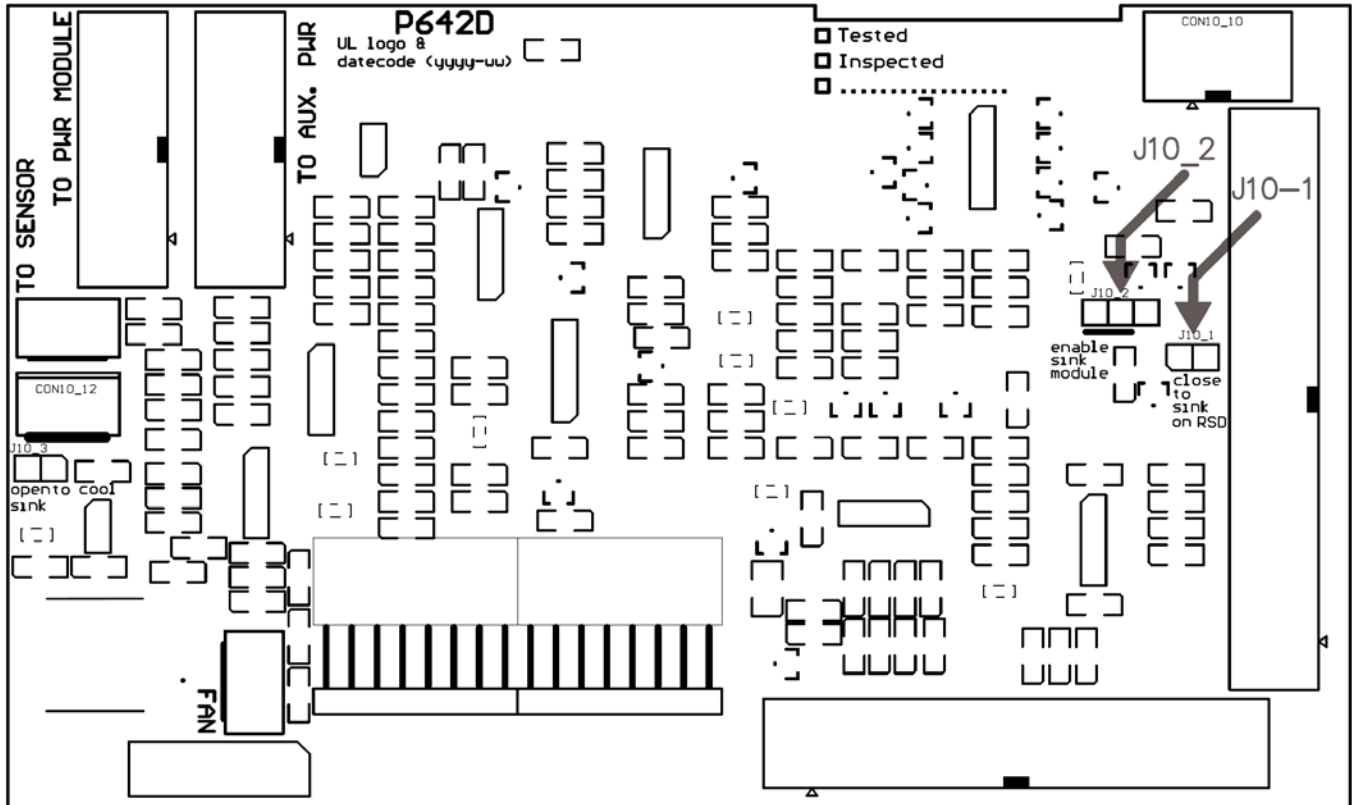

Location of the jumpers J10_1 and J10_2 on P642.

Standard operation

On the front panel the button 'Output On/Off' can be used to switch off the output of the power supply.

If the output has been switched off, also the Power Sink has been switched off.

This means no current can be absorbed by the Power Sink.

The Power Sink will also switch off if the unit goes in OverTemperature (OT) or if the Interlock connection has been interrupted.

Sink on Remote Shut Down

A voltage of +4 V...+12 V on the Remote ShutDown input on the programming connector CON E will switch off the output of the unit. In the standard configuration, Remote ShutDown will not switch off the Power Sink.

This enables high speed down programming of the output voltage, regardless of the load.

For **battery charging applications**, it is strongly advised to remove the link from jumper J10_1.

Like this the Power Sink will switch off after Remote ShutDown, and the battery cannot discharge!

Enable / Disable the Power Sink

In the standard configuration, the Power Sink is enabled and ready for operation.

By changing the position of the jumper J10_2 (set jumper on pin 2 and 3 instead of pin 1 and 2), the Power Sink can be disabled.

Power Sink Overload

If the maximum power has been reached, the Power Sink will go in overload and the sink current will be limited. In this situation the Sink cannot absorb more power and the output voltage of the supply will rise.

On the front panel the LED 'Power Sink OverLoad' will be on and the status output 'PSOL' will be high. On the 15P programming connector 'CON E', the PSOL signal has been placed on pin 6, see figure below. The PSOL signal can be 0 V (low) or 5 V (high). Output impedance is 500 Ohms.

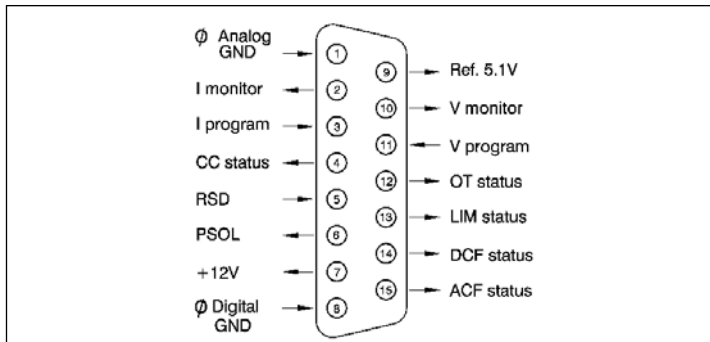

Connections ANALOG PROGRAMMING CONNECTOR

Thermal Overload

If the Power Sink runs hot, the fan starts blowing to cool it down. If the Power Sink still runs hot, the LED 'OverTemp' starts blinking. This is a warning that soon the Power Sink will go in thermal overload.

Once the situation of thermal overload has been reached, the Power Sink shuts down completely until the internal heat sink has cooled down again. Also in this situation the PSOL signal will be high.

Series Operation of units with Power Sink

To enable power sinking in combination with series operation, each unit must have a Power Sink built inside.

The total power that can be absorbed by the series system, is proportional to the number of units in series. For example, three units in series can absorb $3 \times 140 \text{ W} = 420 \text{ W}$ peak power.

If one or more units have no Power Sink, normal series operation is possible, but no power can be absorbed!

For easier control, Master / Slave operation is recommended. Refer to the operation manual of the power supply for details about Master / Slave operation.

Parallel Operation of units with Power Sink

To enable power sinking in combination **with parallel operation, only one unit can have a Power Sink built inside.** The total power that can be absorbed by the parallel system, is equal to the power for one Power Sink (= 140 W peak power). If more than one unit would have a Power Sink inside, the other Power Sinks would be drawing power of the units in the parallel system!

For easier control, Master / Slave operation is recommended. **Always set the unit with Power Sink as master!** If the unit with Power Sink would be set as slave, normal parallel operation is possible, but the sink level will be as high as the maximum output voltage of that unit.

For example, if two SM18-50 would be set to 12 V, only above 18 V the system would start sinking power. Refer to the operation manual of the power supply for details about Master / Slave operation.

Parallel system with Fast Programming and Power Sink

In combination with Fast Programming, the Master / Slave operation is not recommended. In this situation where normal parallel operation is used, the unit with the Power Sink should be set to a fractional higher output voltage (advised +0.2% - +0.5%). A Power Sink that detects a higher output voltage than set on that unit, starts sinking. If one of the units in the parallel system would have a higher voltage, the Power Sink would be constantly sinking this power. The result is reduced output power of the whole system and an Overload condition for the Power Sink. If the Power Sink is in Overload, it cannot absorb power fed back to the unit, which will cause the output voltage to rise.

Parallel programming of a parallel system

For parallel programming of units connected in parallel, the isolation amplifier ISO AMP is recommended. On the ISO AMP connected to the unit with Power Sink, the programming gain must set higher (+0.2% - +0.5%).

This to make sure the unit with the Power Sink has a fractional higher output voltage. For example, programming a 30 V unit with a 0.2% higher gain means that programmed with 5.000 V, the output voltage will be 30.060 V (60 mV = 0.2%).