

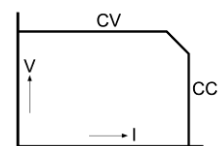

Three phase input

SM6000 - Series 6000W DC POWER SUPPLIES

Models	Voltage range	Current range
SM 15-400	0 - 15 V	0 - 400 A
SM 30-200	0 - 30 V	0 - 200 A
SM 45-140	0 - 45 V	0 - 140 A
SM 60-100	0 - 60 V	0 - 100 A
SM 70-90	0 - 70 V	0 - 90 A
SM 120-50	0 - 120 V	0 - 50 A
SM 300-20	0 - 300 V	0 - 20 A
SM 600-10	0 - 600 V	0 - 10 A

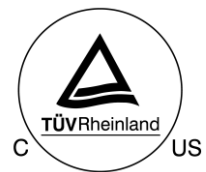

Features

- cTUVus safety approval
- Designed for long life at full power
- Excellent dynamic response to load changes
- Protected against all overload and short circuit conditions
- EMC surpasses CE requirements: low emission & high immunity
- Low audible noise: temperature controlled fans
- Available options: analog & digital Interfaces, High Speed Programming, Digital Encoders, Sequencer, Power Sink etc.

Functionalities

- Master/Slave parallel and series operation with voltage and current sharing
- Stacking is allowed, space between units is not required
- High power system configuration from multiple units
- 19" rack mounting or laboratory use (feet included)
- Remote sensing
- Interlock

	SM 15-400	SM 30-200	SM 45-140	SM 60-100	SM 70-90	SM 120-50	SM 300-20	SM 600-10
DC Power terminals voltage current	0 - 15 V 0 - 400 A	0 - 30 V 0 - 200 A	0 - 45 V 0 - 140 A	0 - 60 V 0 - 100 A	0 - 70 V 0 - 90 A	0 - 120 V 0 - 50 A	0 - 300 V 0 - 20 A	0 - 600 V 0 - 10 A
AC Input 3 phase, 48 - 62 Hz rated voltage range rated frequency rated current current (400 V / 3 ph, full load) power factor, 100%, 50% load internal fuses standby input power ($V_o=I_o=0$) standby input power ($V_o=V_{max}$)	342-528 V 380-480 V 50 / 60 Hz max 12.2A 10.2 A 0.98, 0.97 15 AT 55 W 110 W	342-528 V 380-480 V 50 / 60 Hz max 12.2A 10 A 0.98, 0.97 15 AT 55 W 110 W	342-528 V 380-480 V 50 / 60 Hz max 12.2A 10.3 A 0.98, 0.97 15 AT 55 W 110 W	342-528 V 380-480 V 50 / 60 Hz max 12.2A 10 A 0.98, 0.97 15 AT 55 W 110 W	342-528 V 380-480 V 50 / 60 Hz max 12.2A 10.4 A 0.98, 0.97 15 AT 55 W 130 W	342-528 V 380-480 V 50 / 60 Hz max 12.2A 9.9 A 0.98, 0.97 15 AT 55 W 130 W	342-528 V 380-480 V 50 / 60 Hz max 12.2A 10 A 0.98, 0.97 15 AT 55 W 120 W	342-528 V 380-480 V 50 / 60 Hz max 12.2A 10 A 0.98, 0.97 15 AT 55 W 130 W
Efficiency 400 V AC, 3 ph input, full load	87 %	89 %	90 %	89 %	89 %	89 %	89 %	89 %
Regulation								
Load 0 - 100% CV Line 342 - 457 V AC CV (external voltage sense)	2.5 mV 0.2 mV	5 mV 0.5 mV	5 mV 1 mV	5 mV 2 mV	5 mV 2 mV	8 mV 2 mV	15 mV 3 mV	20 mV 4 mV
Load 0 - 100% CC Line 342 - 457 V AC CC (internal voltage sense, after warm up)	24 mA 4 mA	12 mA 2 mA	9 mA 1.5 mA	6 mA 1 mA	5 mA 1 mA	3 mA 0.5 mA	1.2 mA 0.2 mA	1.0 mA 0.2 mA
Ripple + noise rms (BW=300 kHz) CV p-p (BW=20 MHz) CV rms (BW=300 kHz) CC p-p (BW=20 MHz) CC CC-ripple at full load	0.8 mV 8 mV 100 mA 300 mA	1 mV 8 mV 20 mA 60 mA	1.5 mV 10 mV 8 mA 25 mA	2 mV 10 mV 3 mA 10 mA	2 mV 10 mV 3 mA 10 mA	3 mV 25 mV (20 mV @ full load) 3 mA 10 mA	5 mV 50 mV (30 mV @ full load) 2 mA 5 mA	10 mV 100 mV (80 mV @ full load) 2 mA 5 mA
Temp. coeff., per °C⁻¹ CV CC								35.10 ⁻⁶ 60.10 ⁻⁶
Stability ¹ after 1 hr warm-up during 8 hrs CV CC $t_{amb} = 25 \pm 1$ °C, $V_{in} = 400$ VAC (internal voltage sensing for CC-stab.)								5.10 ⁻⁵ 10.10 ⁻⁵

Analog Programming <i>Not applicable for SM300-20 & SM600-10: see below ISO AMP specs</i>	CV	CC
Programming inputs input range accuracy offset temp. coeff. offset input impedance	0 - 5 V $\pm 0.2\%$ - 0.1 ... +1.3 mV (on 5V) 10 μ V / °C > 1 MOhm	0 - 5 V $\pm 0.5\%$ 0 ... +2.2 mV (on 5V) 50 μ V / °C > 1 MOhm
Monitoring outputs input range accuracy offset temp. coeff. offset input impedance	0 - 5 V $\pm 0.2\%$ - 1 ... 0 mV (on 5V) 3 μ V / °C 2 Ohm / max. 4mA	0 - 5 V $\pm 0.2\%$ - 1.1 ... 0 mV (on 5V) 60 μ V / °C 2 Ohm / max. 4mA
ISO AMP Programming <i>optional for low volt. units up to 120V, standard on SM300-20 and SM600-10.</i>	Isolated analog programming, range 0 - 5 V / 200 kOhm or 0 - 10 V / 400 kOhm. See datasheet ISO AMP on www.DeltaPowerSupplies.com for accuracy, offset etc.	

Reference voltage on prog. connector	V_{ref} TC	5.114 \pm 15 mV ($R_o = 2$ Ohm, max. 4 mA) 20 ppm
+12 V output on prog. Connector	V_o I_{max} R_o	12 V \pm 0.2 V 0.2 A 3 Ohm

Notes: 1. Measured at full load. 2. See "Safety instructions".

Status Outputs CC - status LIM - status OT - status PSOL - status ACF - status DCF - status	CC - operation CV or CC limit Over Temperature Power Sink Overload AC - Fail DC - Fail ¹⁾	5 V = logic 1 (Ro = 500 Ohm) 5 V = logic 1 (Ro = 500 Ohm) 5 V = logic 1 (Ro = 500 Ohm) 5 V = logic 1 (Ro = 500 Ohm) 5 V = logic 1 (Ro = 500 Ohm) 5 V = logic 1 (Ro = 500 Ohm)
Relay Outputs ACF DCF	AC - Fail DC - Fail ¹⁾	both NO and NC contact both NO and NC contact ¹⁾ output ± 5% beyond set point
Remote shutdown	with + 5 V, 1 mA or relay contact	
Interlock	contact at rear panel, see photo of rear panel on page	
Indicators (front panel)	AC-Fail, DC-Fail, Over Temperature, Power Sink Overload, Remote-ShutDown, Remote-CV, Remote-CC, Output On, CV-limit, CC-limit, CV- and CC- mode	
Controls (front panel)	Mains on/off, CV-and CC-potmeter, CV- and CC-limit-potmeter, Display-Settings button, Display-Limits button, Remote/Local, Output On/Off, Front panel Lock	

Programming speed <i>Standard Version</i> (resistive load)	SM 15-400	SM 30-200	SM 45-140	SM 60-100	SM 70-90	SM 120-50	SM 300-20	SM 600-10
Rise time (10 - 90%) output voltage step time, (100 % load) time, (10 % load)	0 → 15 V 3.3 ms 1.3 ms	0 → 30 V 6.4 ms 2.5 ms	0 → 45V 2.7 ms 1.1 ms	0 → 60 V 5.4 ms 2.2 ms	0 → 70 V 6.8 ms 2.8 ms	0 → 120 V 5.1 ms 1.9 ms	0 → 300 V 8.5 ms 3.2 ms	0 → 600 V 12 ms 4.8 ms
Fall time (90 - 10%) output voltage step time, (100 % load) time, (10 % load)	15 → 0 V 3.5 ms 34 ms	30 → 0 V 6.7 ms 67 ms	45 → 0 V 2.9 ms 32 ms	60 → 0 V 5.8 ms 59 ms	70 → 0 V 7.7 ms 77 ms	120 → 0 V 4.9 ms 52 ms	300 → 0 V 8.3 ms 83 ms	600 → 0 V 12 ms 120 ms
Programming speed <i>Optional High Speed</i> (resist. load)	SM 15-400 <i>option 166</i>	SM 30-200 <i>option 167</i>	SM 45-140 <i>option 168</i>	SM 60-100 <i>option 169</i>	SM 70-90 <i>option 170</i>	SM 120-50 <i>option 171</i>	SM 300-20 <i>option 172</i>	SM 600-10 <i>option 270</i>
Rise time (10 - 90%) output voltage step time, (100 % load) time, (10 % load)	0 → 15 V 0.40 ms 0.38 ms	0 → 30 V 0.41 ms 0.38 ms	0 → 45V 0.53 ms 0.16 ms	0 → 60 V 0.44 ms 0.41 ms	0 → 70 V 0.62 ms 0.40 ms	0 → 120 V 0.57 ms 0.19 ms	0 → 300 V 1.1 ms 0.44 ms	0 → 600 V 1.9 ms 0.80 ms
Fall time (90 - 10%) output voltage step time, (100 % load) time, (10 % load)	15 → 0 V 0.39 ms 1.5 ms	30 → 0 V 0.41 ms 3.6 ms	45 → 0 V 0.26 ms 10 ms	60 → 0 V 0.57 ms 5.6 ms	70 → 0 V 0.50 ms 6.2 ms	120 → 0 V 0.38 ms 4.2 ms	300 → 0 V 1.0 ms 10 ms	600 → 0 V 2.2 ms 20 ms
Ripple @ full load typical (rms/pp)	6/20mV	28/80mV	34/80mV	34/90mV	38/100mV	30/120mV	48/150mV	35/220mV
Output Capacitance (typical)	1200 µF	800 µF	520 µF	330 µF	290 µF	73 µF	32 µF	19 µF

	SM 15-400	SM 30-200	SM 45-140	SM 60-100	SM 70-90	SM 120-50	SM 300-20	SM 600-10
Recovery time recovery within di/dt of load step output voltage time, @ 50 - 100% load step max. deviation	60 mV 5 A/µs 13 V 120 µs 320 mV	50 mV 2.5 A/µs 25 V 100 µs 260 mV	100 mV 1.8 A/µs 40 V 100 µs 380 mV	100 mV 1.3 A/µs 55 V 100 µs 250 mV	100 mV 1.7 A/µs 65 V 100 µs 280 mV	0.5 V 1 A/µs 110 V 100 µs 1 V	1 V 0.25 A/µs 280 V 100 µs 1.8 V	1 V 0.12 A/µs 560 V 100 µs 1.8 V
Output impedance CV, 0-1 kHz CV, 1-100 kHz	< 0.5 mΩ < 2.3 mΩ	< 1.2 mΩ < 5 mΩ	< 1.7 mΩ < 10 mΩ	< 1.5 mΩ < 12 mΩ	< 1.8 mΩ < 12 mΩ	< 11 mΩ < 90 mΩ	< 34 mΩ < 330 mΩ	< 70 mΩ < 700 mΩ
Pulsating load max. tolerable AC component of load current f > 1 kHz f < 1 kHz	30 A _{rms} 400 A _{peak}	35 A _{rms} 200 A _{peak}	20 A _{rms} 140 A _{peak}	20 A _{rms} 100 A _{peak}	20 A _{rms} 90 A _{peak}	10 A _{rms} 50 A _{peak}	5 A _{rms} 20 A _{peak}	2.5 A _{rms} 10 A _{peak}

Insulation AC mains / DC power terminals creepage / clearance AC mains / case DC power terminals / case	3750 V _{rms} (1min.) 8 mm 2500 V _{rms} 600 V DC ²⁾
Safety	cTUVus / EN 60950 / EN 61010
EMC Emission Immunity	EN 61326-1 , class B equipment (for use in domestic establishments) EN 61326-1 , equipment for use in industrial and domestic establishments

Notes: 1. Measured at full load. 2. See "Safety instructions".

Operating Temperature at full load	- 20 to + 50 °C derate output to 75% at 60 °C
Humidity	maximum 95% RH, non condensing, up to 40 °C maximum 75% RH, non condensing, up to 50 °C
Storage temperature	- 40 to + 85 °C
Thermal protection	output shuts down in case of insufficient cooling
MTBF	500 000 hrs

	SM 15-400	SM 30-200	SM 45-140	SM 60-100	SM 70-90	SM 120-50	SM 300-20	SM 600-10
Hold-Up time (@ 400 VAC input)								
$V_{out} = 100\%$, $I_{out} = 100\%$	11 ms	11 ms	11 ms	11 ms	13 ms	13 ms	12 ms	11 ms
$V_{out} = 85\%$, $I_{out} = 100\%$	23 ms	23 ms	23 ms	24 ms	23 ms	24 ms	24 ms	23 ms
$V_{out} = 100\%$, $I_{out} = 50\%$	33 ms	28 ms	27 ms	28 ms	30 ms	32 ms	28 ms	27 ms
Turn on delay after mains switch on	200 ms							
Inrush current	20 A (electronic limit)							
Phase loss	Output shuts down in case of phase loss.							

	SM 15-400	SM 30-200	SM 45-140	SM 60-100	SM 70-90	SM 120-50	SM 300-20	SM 600-10
Series operation max. total voltage Master / Slave operation	600 V ² yes							
Parallel operation Normal Master / Slave operation	no limit maximum 3 units							
Remote sensing max. voltage drop per load lead	2 V							
Limits Voltage adjust range Current adjust range	0 - 102 % 0 - 102 %							
Front panel CV/CC-controls resolution knob operation screwdriver adjustment Lock function for CV/CC-settings Selectable Start-up at 0V / 0A or at last settings	analog potentiometers ³⁾ 10 turns (0.03%) standard optional (P001) no no						digital encoders 10 or 64 turns ⁴⁾ standard no yes yes	
	<i>³⁾optional with digital encoders (P220) : specifications for controls are similar to SM300-20 and SM600-10.</i>						<i>⁴⁾variable pitch depending on operation speed</i>	
Meters scale voltage scale current accuracy read output read limit setting (d = digit)	3.5 digit 0 - 15.00V 0 - 400 A 0.5% + 2d 2% + 2d	3.5 digit 0 - 30.0 V 0 - 200 A 0.5% + 2d 2% + 2d	3.5 digit 0 - 45.0 V 0 - 140.0A 0.5% + 2d 2% + 2d	3.5 digit 0 - 60.0 V 0 - 100.0A 0.5% + 2d 2% + 2d	3.5 digit 0 - 70.0V 0 - 90.0 A 0.5% + 2d 2% + 2d	3.5 digit 0 - 120.0V 0 - 50.0 A 0.5% + 2d 2% + 2d	3.5 digit 0 - 300 V 0 - 20.0 A 0.5% + 2d 2% + 2d	3.5 digit 0 - 600 V 0 - 10.0 A 0.5% + 2d 2% + 2d

Mounting	stacking of units allowed, air flow is from left to right							
AC Terminals	screw terminals for wire 2.5 - 4 mm ² , 3 phase + earth (no neutral)							
DC Terminals	M12 bolts	M10 bolts	M10 bolts	M10 bolts	M10 bolts	M8 bolts	M8 bolts	M8 bolts
Programming connector	15 pole D-connector at rear panel							
Interlock	contact at rear panel							
Cooling audio noise level air flow	low noise blower, fan speed adapts to temperature of internal system ca. 56 dBA at full load, 25 °C ambient temperature, 1 m distance ca. 62 dBA at full load, 50 °C ambient temperature, 1 m distance From left to right							
Enclosure degree of protection	IP20							
Dimensions front panel: h x w behind front panel: h x w x d	177 x 483 mm (19", 4 U) 177 x 443 x 500mm							
Weight	27 kg							

CV = Constant Voltage CC = Constant Current
 Specifications measured at $t_{amb} = 25 \pm 5 \text{ °C}$ and $V_{in} = 400 \text{ VAC}$, 50 Hz
 unless otherwise noted.
 The information in this document is subject to change without notice.
 Notes: 1. Measured at full load.
 2. See safety Instructions in the operating manual.

Typical Applications

- Solar inverter testing, PV-Simulation
- Hybrid Car testing systems
- ATE in industrial production lines
- Plasma chambers
- Automotive battery simulations
- Controlled battery (dis)charging
- Lasers
- Sustainable energy
- Driving PWM-Controlled DC motors
- Accurate current sources
- Aerospace and military equipment

Available Options



Increased Output Power

The conservatively rated unit allows to deliver extra output with the same reliability.

At some derating, either the maximum output voltage or the maximum output current can be increased by about 10%.

Order Code :

- P069



High Speed Programming

A 10 to 20 times higher programming speed (down to 0.4ms rise time at full load) and lower output capacitance¹⁾. Excellent for laser applications, test systems or as current source with low parallel capacitance as used in plasma chambers.

Order Codes :

- SM 15-400 P166 – SM30-200 P167
- SM 45-140 P168 – SM60-100 P169
- SM 70-90 P170 – SM120-50 P171
- SM 300-20 P172 – SM600-10 P270



Two-Quadrant Output Power Sink

Two quadrant operation maintains the DC output voltage constant regardless the output power is positive or negative¹⁾. Ideal for PWM-speed controlled DC-Motors and ATE systems.

Order Codes :

- SM 15-400 P230 – SM30-200 P231
- SM 45-140 P232 – SM60-100 P233
- SM 70-90 P234



Sequencer

Arbitrary Waveform generator or standalone automation. The sequencer

Is integrated in the Ethernet controller.

Order Code :

- P157

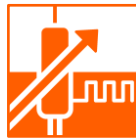

Digital CV- and CC-Settings

Reliable, long-life digital encoders can be implemented at the front panel. Includes total front panel lock (also for CV- / CC-knobs) and a coarse or fine pitch adjustment depending on the turning speed. Is standard on SM300-20 and SM600-10.

Order Code :

- P220



Secured Voltage and Current Settings

For maximum security, the CV/CC settings can be adjusted with a screwdriver only and are protected with a plastic cap from accidental adjusting. SM300-20, SM600-10 and units with option P220 already have secured settings.

Order Code :

- P001



Software Control and Interfaces

Interfaces to be installed by factory²⁾.

Order Code:

- ISO AMP Card - isolated analog - P154³⁾
- RS232 controller - P155
- IEEE488 controller - P156
- Ethernet controller - P157 (including sequencer)

Notes: 1. Download datasheets about High Speed Programming, Power Sink and Battery Charging from www.DeltaPowerSupplies.com.
2. There is only room for one of the interfaces in a unit.
3. SM300-20, SM 600-10 are standard equipped with ISO AMP, this can be replaced by RS232 or IEEE488 controller (P155 or P156).

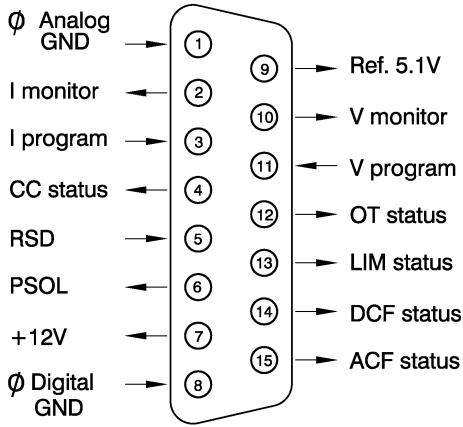

CV = Constant Voltage
CC = Constant Current

Specifications measured at
 $t_{amb} = 25 \pm 5 \text{ }^\circ\text{C}$ and $V_{in} = 400 \text{ VAC}$,
50 Hz unless otherwise noted.

The information in this document is
subject to change without notice.

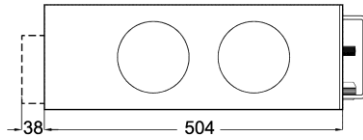
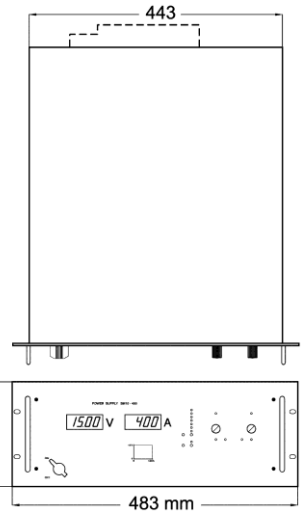

Connections analog programming connector

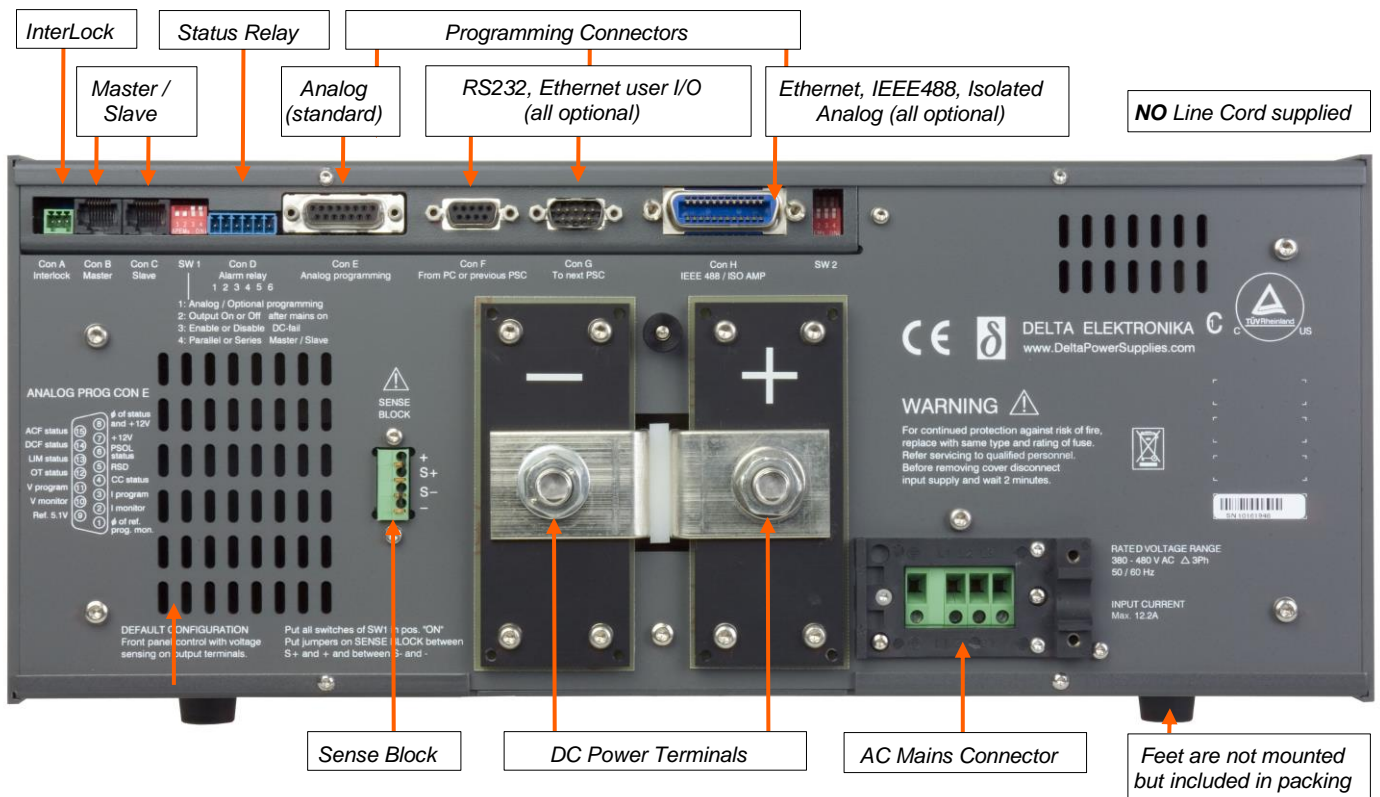

Safety Covers supplied for in- and output (not shown)

Note: SM300-20, SM600-10 are standard equipped with isolated analog programming via ISO AMP on CON H (CON E is not available).

