



# ISO AMP-series

- ISO AMP CARD
- ISO AMP MODULE

## **Product Manuals and Driver & Example Software**

For several Applications there are Application Notes available on our website.  
See **PRODUCTSINTERFACES**.

## **PRODUCT MANUAL**

Contents:

- 1 – **Safety Instructions**
- 2 – **Sicherheitshinweise**
- 3 – **Installation**
- 4 – **Operation & Calibration**
- 5 – **EU Declaration of Conformity**

# 1 Safety Instructions

## 1.2 Caution

The following safety precautions must be observed during all phases of operation, service and repair of this equipment. Failure to comply with the safety precautions or warnings in this document violates safety standards of design, manufacture and intended use of this equipment and may impair the built-in protections. Delta Elektronika shall not be liable for user's failure to comply with these requirements.

## 1.3 Installation Category

The Delta Elektronika interfaces have been evaluated to installation category II (Over voltage category II).

## 1.4 Grounding

This product is a safety Class 1 equipment. For safety isolation both the metal assembly terminals next to the 15p connector must be firmly connected to the metal chassis of a grounded Delta Elektronika power supply. Any interruption of the protective ground conductor, or disconnection of the metal terminals will cause a potential shock hazard that might cause personal injury.

For grounding of the power supply, see the specific power supply operating manual for detailed safety instructions.

## 1.5 Live Circuits

Operating personnel should not remove the unit covers. No internal adjustment or component replacement is allowed by non Delta Elektronika qualified personnel. Never replace components with the power cable connected. To avoid injuries, always disconnect power, remove external voltage sources and discharge circuits before touching components.

## 1.6 Parts Substitutions & Modifications

Parts substitutions and modifications are allowed by authorized Delta Elektronika service personnel only. For repairs the unit must be returned to a Delta Elektronika service facility.

## 1.7 Removal of (safety) covers

Safety cover(s) are used to cover potentially hazardous voltages.

Observe the following when removing safety cover(s):

- Switch off the unit and disconnect the unit from the AC mains supply and from the DC power application.
- Wait for 5 minutes to allow internal capacitors to discharge, then unscrew and remove the cover(s).
- Always place the cover(s) back before connecting the unit to the mains supply again.

## 1.8 Environmental Conditions

- The Delta Elektronika power supplies safety approval applies to the following operating conditions:
- Usage : Indoor use only.  
**Warning!** Not intended to be used in the presence of children or animals!
- Ambient temperature : -20 to 50 °C.
- Maximum relative humidity : 95%, non condensing, up to 40 °C, 75%, non condensing, up to 50 °C.
- Altitude : Do not use above 2000 m sea level.  
**Warning!** Electrical Creepage & Clearance not valid for higher altitudes!
- Pollution degree : 2

## 1.9 Symbols & markings



*Caution risk of electrical Shock.*



*Instruction manual symbol. The instrument will be marked with this symbol when it is necessary for the user to refer to the instruction manual.*



*Protective ground conductor terminal.*



*Off (supply).*



*On (supply).*

## WEEE (Waste Electrical & Electronic Equipment)

### 1.1 Correct Disposal of this Product

Applicable in the European Union.



This marking shown on the product, its packing or its literature indicates that it should not be disposed with other wastes at the end of its working life, but should be collected separately to recycle it responsibly to promote the sustainable reuse of material resources.

## 2 Sicherheitshinweise

### 2.1 Vorsicht

Die folgenden Sicherheitsvorkehrungen müssen in allen Betriebs-, Service- und Reparaturphasen dieses Geräts befolgt werden. Die Nichteinhaltung der Sicherheitsvorkehrungen oder Warnungen in diesem Dokument verstößt gegen die Sicherheitsstandards im Hinblick auf Bauart, Produktion und vorgesehene Nutzung dieses Geräts und kann die eingebauten Schutzvorrichtungen beschädigen. Delta Elektronika haftet nicht dafür, wenn der Nutzer diesen Anforderungen nicht nachkommt.

### 2.2 Installationskategorie

Die Delta Elektronika Schnittstellen wurden der Installationskategorie II (Überspannungskategorie II) zugeordnet.

### 2.3 Erdung

Dieses Produkt ist ein Gerät der Sicherheitsklasse 1. Zur Sicherheitsisolierung müssen beide Metallmontageklappen neben dem 15p-Stecker fest mit dem Metallgehäuse eines geerdeten Delta Elektronika Netzteils verbunden sein. Jede Unterbrechung des Schutzleiters oder das Abschalten der Metallklappen führt zu einer potenziellen Schockgefahr, die zu Personenschäden führen kann.

Zur Erdung des Netzteils siehe spezifische Betriebsanleitung für die Stromversorgung.

### 2.4 Spannungsführenden Stromkreise

Bedienungspersonal darf die Geräteabdeckungen nicht entfernen. Interne Einstellungen oder Bauteilaustausche sind ausschließlich qualifiziertem Personal von Delta Elektronika gestattet. Bauteile nie bei eingestecktem Stromkabel austauschen. Um Verletzungen zu vermeiden, vor dem Berühren von Bauteilen immer den Strom trennen, externe Spannungsquellen entfernen und Stromkreise entladen.

### 2.5 Teileaustausch & Modifikationen

Teileaustausch und Modifikationen sind ausschließlich autorisiertem Delta Elektronika-Service-Personal gestattet. Reparaturen am Gerät dürfen nur durch eine Delta Elektronika-Serviceeinrichtung durchgeführt werden.

### 2.6 Entfernung von (Sicherheits-) Abdeckungen

Sicherheitsabdeckung(en) werden verwendet, um potenziell gefährliche Spannungen abzudecken. Beachten Sie Folgendes, wenn Sie die Sicherheitsabdeckung(en) entfernen:

- Gerät ausschalten, Gerät von dem AC-Versorgungsnetz und DC-Anwendung trennen.
- Warten Sie 5 Minuten um interne Kondensatoren zu entladen. Abschrauben und entfernen von Abdeckung(en).
- Bevor Sie das Gerät wieder mit dem Versorgungsnetz verbinden, montieren Sie vorher jedes Mal die Abdeckung(en).

Plötzliches Machen oder Brechen von hohen Gleichstrom kann große Funken verursachen, auch bei niedriger Spannung. Gefahr von thermischen Verbrennung und Feuer!

### 2.7 Umgebungsbedingungen

Die Stromversorgungssicherheitszulassung von Delta Elektronika gilt für die folgenden Betriebsbedingungen:

- Gebrauch : Nur Innengebrauch. **Warnung!** Nicht für die Verwendung in Gegenwart von Kindern oder Tieren vorgesehen!
- Umgebungstemperatur : -20 bis 50 °C.
- Maximale relative Luftfeuchtigkeit : 95%, nicht kondensierend, bis zu 40 °C, 75%, nicht kondensierend, bis zu 50 °C
- Höhe : Nicht über 2000 m Meeresspiegel verwenden.  
**Warnung!** Elektrische Creepage & Clearance nicht gültig für größere Höhen!
- Verschmutzungsgrad : 2

### 2.8 Symbole und Markierungen



Vorsichtsgefahr bei elektrischen Schlag.



PE-leiterklemme.



Bedienungsanleitung Symbol. Das Gerät wird mit diesem Symbol gekennzeichnet, wenn der Benutzer auf die Bedienungsanleitung verweisen muss.



Aus (Versorgungsnetz).



Ein (Versorgungsnetz).

## WEEE (Waste Electrical & Electronic Equipment)

### 2.9 Korrekte Entsorgung dieses Produkts

Anwendbar in der Europäischen Union.



Diese Kennzeichnung auf dem Produkt, seiner Verpackung oder seiner Literatur weist darauf hin, dass es am Ende seiner Lebensdauer nicht mit anderen Abfällen entsorgt, sondern separat gesammelt werden sollte, um es verantwortungsvoll zu recyceln, um die nachhaltige Wiederverwendung von Material zu fördern.

### 3 Installation

- **Warning!** carefully read the chapter "Safety Instructions" in this manual before connecting or operating the unit!

#### 3.1 HUMIDITY & CONDENSATION

- During normal operation, humidity will not harm the interface, provided the air is not aggressive. The heat normally produced in the power supply will keep it dry.
- Avoid condensation inside the interface, to prevent break-down. Condensation can occur during a period the interface or power supply has been switched off (or operating at no load) and the ambient temperature is increasing. Always allow the interface to dry before switching it on again.

#### 3.2 TEMPERATURE & COOLING

- The storage temperature range is -40 to +85 °C.
- The operating temperature range is -20 to +50 °C.
- Please note: a lower temperature extends the lifetime of the interface.

#### 3.3 INSTALLING THE ISO AMP MODULE

- Mount the ISO AMP MODULE using the wall or rail mounting adapter.
- Connect the power supply to the ISO AMP MODULE with the supplied 15 pole cable.
- Connect a 15-30 V DC supply voltage to the 2-pole connector. + and - are indicated on the module, see fig 4 -1.
- Finally connect your programming source to the connector marked 'TO PROG. SOURCE', see fig 4 -1 and fig 4 -2.
- For use with other units than Delta Elektronika power supplies, make sure to connect pin 1 to pin 8 on the connector 'To Power Supply', see fig 4 -3.

#### 3.4 WALL OR RACK MOUNTING

- Use the included mounting plate, see fig 4 -4, for attaching the module to a rack or a wall.
- No special cooling is required, the module does not heat up more than 10 degrees above ambient temperature.

#### 3.5 INSTALLING THE ISO AMP CARD

- The ISO AMP CARD should always be factory installed and calibrated together with the power supply.
- Contact factory for more information.
- For operation, connect a 15 pole cable to the ISO AMP connector at the rear side of the power supply.
- For the following steps, please advice the operating manual of the power supply for exact details.

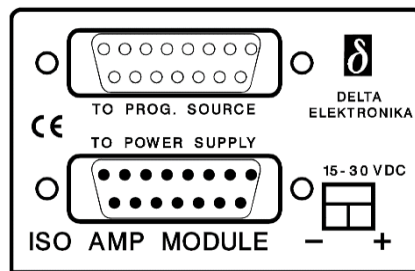

fig 4 - 1  
Front panel connections.

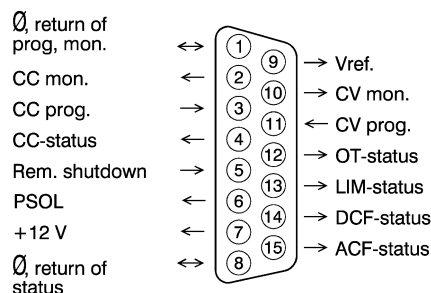

fig 4 - 2  
To programming source.

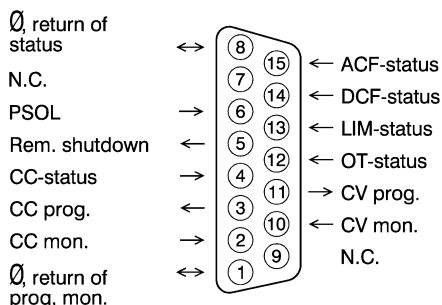

fig 4 - 3  
To power supply.

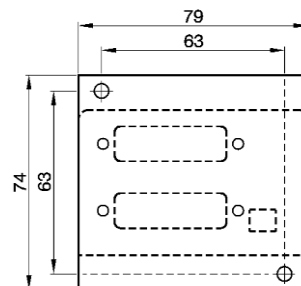

fig 4 - 4  
A wall mounting adapter is standard supplied with the ISO AMP Module

## 4 Operation & Calibration

### 4.1 GENERAL

- If you have a question about the unit, please contact our engineers using the address Support@Delta-Elektronika.nl.
- In case the unit is defect, please first fill out the RMA-form before sending the unit to us. Adding a detailed fault description will help us to repair the unit as soon as possible. Do not try to repair the unit yourself.
- On our website the RMA-form can be found under 'Support'.

### 4.2 POWER SUPPLY SET-UP

- For settings of remote programming and monitoring please refer to the power supplies' manual.
- Note that the warning that the Ø of the programming input of the power supply is no longer connected to the minus DC Power Terminal, when the ISO AMP is used.
- The ES- and SM-series power supplies do not need any maintenance or calibration. However, care must be taken that the cooling of the unit is not obstructed.

### 4.3 ISO AMP CONFIGURATION

- The ISO AMP can be configured for both 5V and 10 V signal levels. Selecting a signal level is done by closing or opening DIP-jumpers.
- Take proper **ESD precautions** before setting the jumpers.
- See fig. 5 - 1 for lay-out for ISO AMP PCB P512 rev.B.
- A closed jumper is 0- 5V, an opened jumper 0-10 V. The signal level for each of the four analog channels can be selected individually. See table 5 -1.
- The full scale of the analog channels of the ISO AMP is factory calibrated within 0.1% for a 5 V signal level.
- Configuring jumper J1...J4 for 10 V signal levels without re-calibrating can introduce an extra full scale error of 0.1%. Table 5 - 2 shows the full scale calibration trimmers.
- **Warning:** before proceeding with the calibration of the ISO AMP make sure that your measuring equipment has the correct voltage and current rating.

### 4.4 ISO AMP VOLTAGE CALIBRATION

- Connect a suitable, high accuracy volt meter to the output terminals of the power supply and put the CV programming switch on the power supply in the position 'PROG'.
- Apply 5.000 V or 10.000 V (depending on the jumper setting) to the CV<sub>PROG</sub> input.
- Calibrate the output voltage of the power supply with R51.
- Connect the volt meter to the CV<sub>MON</sub> connection and calibrate the CV<sub>MON</sub> signal with R29.

### 4.5 ISO AMP CURRENT CALIBRATION

- Switch off the power supply, connect a suitable, high accuracy current meter across the output terminals of the power supply.
- Put the CC programming switch on the power supply in the position 'PROG'.
- Apply 5.000 V or 10.000 V (depending on the jumper setting) to the CC<sub>PROG</sub> input.
- Calibrate the output current of the power supply with R40.
- Connect a volt meter to the CCMON connection and calibrate the CCMON signal with R18.
- **Warning!** Wrong calibration can damage the unit.

### 4.6 Other

- If there is a fault or inaccuracy that cannot be compensated with the calibration range, please fill out the RMA-form on our website [www.delta-elektronika.nl](http://www.delta-elektronika.nl). See previous paragraph 1).

Signal	Jumpers
CV <sub>prg</sub>	closed=5 V, open=10 V
CC <sub>prg</sub>	closed= +/-5 V, open= +/-10 V
CV <sub>mon</sub>	closed=5 V, open=10 V
CC <sub>mon</sub>	closed= +/-5 V, open= +/-10 V

table 5 -1  
Jumper settings.

Signal	Trimmers (full scale)
CV <sub>prg</sub>	R51
CC <sub>prg</sub>	R40
CV <sub>mon</sub>	R29
CC <sub>mon</sub>	R18

table 5 -2  
Trimmer settings.

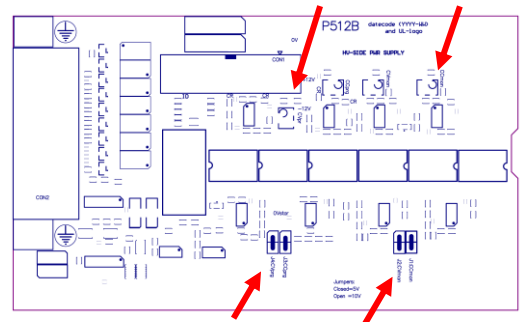

fig 5 - 1  
Location of jumpers and trimmers on P512 revision B.

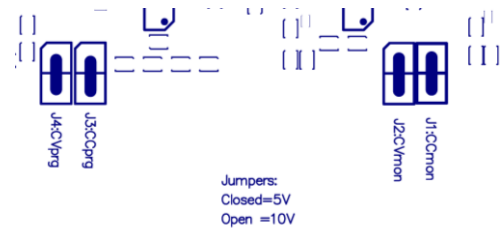

fig 5 - 2  
Legend for jumpers for ISO AMP (P512B).

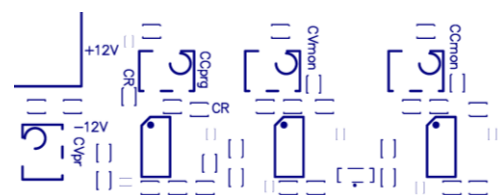

fig 5 - 3  
Legend for trimmers ISO AMP (P512 B).



## 5 EU Declaration of Conformity



We

Delta Elektronika  
Vissersdijk 4  
4301 ND ZIERIKZEE  
The Netherlands

Declare under sole responsibility that the following interfaces:

**ISO AMP CARD**  
**ISO AMP MODULE**

Meet the intent of Directives

2014/30/EU Electromagnetic Compatibility (EMC)  
2014/35/EU Low Voltage Directive (LVD)  
2011/65/EU Reduction of Hazardous Substances (RoHS2)

Compliance was demonstrated to the following specification as listed in the official Journal of the European Communities:

**EN 61326-1:2013 EMC requirements for electrical equipment for measurement, control and laboratory use**

**EN 61010-1:2010 Safety requirements for electrical equipment for measurement, control and laboratory use**

**EN IEC 63000:2018 Assessment of electrical and electronic products with respect to RoHS**

J. Koopman  
Managing director,  
Zierikzee, April 2024