



SM15K-series

- **SM 70-CP-450**
- **SM 210-CP-150**
- **SM 500-CP-90**
- **SM 1500-CP-30**

Firmware Update

It is strongly recommended, first to perform a firmware update before further operation. Download the SM15K Quick Start Manual for instructions.

Driver & Example Software

For several applications and Interfaces there is Driver & Example Software available on our website. See [PRODUCTS\SM15K\DOWNLOADS](#).

PRODUCT MANUAL

Firmware version P0170 and newer

Contents:

- 1 – **Safety Instructions**
- 2 – **Sicherheitshinweise**
- 3 – **Consignes de Sécurité**
- 4 – **Quick Start**
- 5 – **General**
- 6 – **Installation**
- 7 – **Front Menu Operation**
- 8 – **Remote Programming**
- 9 – **Trouble Shooting**
- 10 – **Maintenance & Calibration**
- 11 – **EU Declaration of Conformity**

1 SAFETY INSTRUCTIONS - SM15K-series

1.1 Caution

The following safety precautions must be observed during all phases of operation, service and repair of this equipment. Failure to comply with the safety precautions or warnings in this document violates safety standards of design, manufacture and intended use of this equipment and may impair the built-in protections. Delta Elektronika shall not be liable for user's failure to comply with these requirements.

1.2 Installation Category

The Delta Elektronika power supplies have been evaluated to installation category II (Over voltage category II).

1.3 Grounding of Mains Terminals (AC Power Terminals)

This product is a safety Class 1 unit. To minimize shock hazard, the unit must be connected to the AC Power Supply mains through a four-conductor power cable, with the ground wire firmly connected to an electrical ground (safety ground) at the power outlet.

For units designed to be hard-wired to the mains supply, the protective earth terminal must be connected to the safety electrical ground before another connection is made. Any interruption of the protective ground conductor, or disconnection of the protective earth terminal will cause a potential shock hazard that might cause personal injury.

1.4 Grounding of DC Power Terminals

If the DC power terminal of a unit is specified to sink or source to a maximum of 60VDC, and either the 'minus' or 'plus' DC power terminal is grounded, the voltage on the DC power terminals and sense connections can be considered safe.

Warning! When the 'plus' DC power terminal can exceed 60VDC in respect to the 'minus' DC power terminal, additional external measures must be taken to ensure safety isolation of the DC power terminals and sense connections.

Warning! When the 'minus' DC power terminal of the unit can exceed 60VDC / 42.4Vpk in respect to ground, additional external measures must be taken to ensure safety isolation of the DC power terminals and sense connections.

The standard LAN, USB and Interlock connectors and optional interfaces are at ground level and can be considered safe if the 'minus' DC power terminal of the unit does not exceed 1000VDC / 707Vpk in respect to ground for SM70-CP-90, SM210-CP-150 and SM500-CP-90 or does not exceed 1500VDC / 1060Vpk in respect to ground for SM1500-CP-30.

Caution 1: If a low voltage unit has both DC power terminals floating, or if the terminals are in series with an external high AC or DC voltage, the 'minus' DC power terminal can exceed the safe value in respect to ground as specified in the above warning!

Caution 2: Although a high voltage unit is set to a safe voltage below 60VDC, for safety it must always be considered as a high voltage unit! Wrong operation, a programming error or an external defect can result in an unsafe high DC output voltage.

For more information regards Grounding & Safety, see the online application note "*Safe operation of a power supply*".

1.5 Danger of electrical shock

Touching the contacts of the mains plug or wires directly after disconnecting from the mains, can cause an electrical shock. And there can still be a dangerous voltage between one of the DC power terminals and the PE because of charged X-capacitors. This can also happen when the DC power output is switched off, but the unit is still switched on! Therefore never touch PE and one of the DC power terminals at the same time.

1.6 Connection to mains supply

Either connect to the mains supply permanently or via an industrial type plug, complying with IEC 60309. "Permanently connected equipment" or "Pluggable equipment type B".

1.7 Fuses

Fuses to be changed by authorized Delta Elektronika service personnel only, for continued protection against risk of fire.

1.8 AC Input Ratings

Do not use an AC Supply which exceeds the AC input voltage and frequency rating of this unit. The AC input voltage and frequency rating of the Delta Elektronika power supply series are stated in the accompanying datasheet.

1.9 Live Circuits

Operating personnel should not remove the unit covers. No internal adjustment or component replacement is allowed by non Delta Elektronika qualified personnel. Never replace components with the power cable connected. To avoid injuries, always disconnect power, remove external voltage sources and discharge circuits before touching components.

1.10 Parts Substitutions & Modifications

Parts substitutions and modifications are allowed by authorized Delta Elektronika service personnel only. For repairs or modifications the unit must be returned to a Delta Elektronika service facility.

1.11 Removal of (safety) covers

Safety cover(s) are used to cover potentially hazardous voltages.

Observe the following when removing safety cover(s):

- Switch off the unit and disconnect the unit from the AC mains supply and from the DC power application.
- Wait for 5 minutes to allow internal capacitors to discharge, then unscrew and remove the cover(s).
- Always place the cover(s) back before connecting the unit to the mains supply again.

1.12 Handling and mounting

Warning! Unit weight is 27kg! Take care when unpacking or moving unit: lift with 2 persons or use a lift tool.

- Risk of crushing or clamping of limbs!
- Risk of cutting: unit has sharp edges and corners!

Warning! No wall mounting or ceiling mounting allowed! Risk of crushing under unit.

Only mount unit horizontally, place on a stable surface or use rack mounting.

1.13 Rotating fan, thermal burn

Proper air flow is required for cooling of the unit. This enables operation at full power and a longer life time.

If the unit gets over heated, the power will shut down until unit has cooled down again.

Warning! Top cover and fan exhausts can get hot. Avoid touching these while operating the unit at high power!

Warning! Do not block fan openings, or air exhausts. Do not try to enter fan openings by any object to obstruct fan. Long hair can get stuck in fan, wear a hairnet if you have long hair.

Warning! Do not (dis)connect cables to the DC power terminals while the unit is on. Sudden making or breaking of high DC currents can cause large sparks, even at low voltages. Risk of thermal burn and fire!

1.14 Electro medical devices

Warning! High currents can run through the DC power terminals. These currents cause strong magnetic fields. Do not come near if you have an electro medical device such as a pacemaker.

1.15 Environmental Conditions

- The Delta Elektronika power supplies safety approval applies to the following operating conditions:

- Usage : Indoor use only.
Warning! Not intended to be used in the presence of children or animals!
- Ambient temperature : -20 to 50 °C.
- Maximum relative humidity : 95%, non-condensing, up to 40 °C, 75%, non-condensing, up to 50 °C.
- Altitude : Do not use above 2000 m sea level.
Warning! Electrical Creepage & Clearance not valid for higher altitudes!
- Pollution degree : 2

1.16 Symbols & markings



Caution risk of electrical Shock.



Instruction manual symbol. The instrument will be marked with this symbol when it is necessary for the user to refer to the instruction manual.



Protective ground conductor terminal.



Off (supply).



On (supply).

WEEE (Waste Electrical & Electronic Equipment)

1.17 Correct Disposal of this Product

Applicable in the European Union.



This marking shown on the product, its packing or its literature indicates that it should not be disposed with other wastes at the end of its working life, but should be collected separately to recycle it responsibly to promote the sustainable reuse of material resources.

2 SICHERHEITSHINWEISE - SM15K-series

2.1 Vorsicht

Die folgenden Sicherheitsvorkehrungen müssen in allen Betriebs-, Service- und Reparaturphasen dieses Geräts befolgt werden. Die Nichteinhaltung der Sicherheitsvorkehrungen oder Warnungen in diesem Dokument verstößt gegen die Sicherheitsstandards im Hinblick auf Bauart, Produktion und vorgesehene Nutzung dieses Geräts und kann die eingebauten Schutzvorrichtungen beschädigen. Delta Elektronika haftet nicht dafür, wenn der Nutzer diesen Anforderungen nicht nachkommt.

2.2 Installationskategorie

Die Stromversorgungen von Delta Elektronika wurden der Installationskategorie II (Überspannungskategorie II) zugeordnet.

2.3 Erdung der Netzanschlussklemmen (AC-Einspeiseklemmen)

Dieses Produkt ist ein Gerät der Sicherheitsklasse 1. Um die Gefahr eines elektrischen Schlags zu minimieren, muss das Gerät mit einem Vierleiter-Stromkabel mit dem AC-Stromversorgungsnetz verbunden werden. Hierbei muss der Schutzleiter fest mit einem elektrischen Erdungsanschluss (Schutzleiter) an der Stromquelle verbunden sein. Bei Geräten, die fest mit dem Versorgungsnetz verdrahtet werden, muss die Schutzerdungsklemme mit dem Sicherheitserdungsanschluss verbunden werden, bevor eine andere Verbindung hergestellt wird. Eine Unterbrechung des Schutzleiters oder eine Trennung der Schutzerdungsklemme kann zu einem elektrischen Schlag führen, der zur Verletzung von Personen führen kann.

2.4 Erdung der DC-Anschlussklemmen

Wenn die DC-Anschlussklemme eines Geräts dafür ausgelegt ist, maximal 60 VDC zu empfangen oder zu beziehen und entweder die 'minus' oder 'plus' DC-Anschlussklemme geerdet ist, kann die Spannung auf den DC-Anschlussklemmen und Sense-Verbindungen als sicher angesehen werden.

Warnung! Wenn die 'plus' DC-Anschlussklemme im Verhältnis zur 'minus' DC-Anschlussklemme 60 VDC überschreiten kann, müssen zusätzliche externe Maßnahmen ergriffen werden, um die Sicherheitsisolation der DC-Anschlussklemmen und Sense-Verbindungen sicherzustellen.

Warnung! Wenn die 'minus' DC-Anschlussklemme im Verhältnis zur Erdung 60 VDC/42,4 Vpk überschreiten kann, müssen zusätzliche externe Maßnahmen ergriffen werden, um die Sicherheitsisolation der DC-Anschlussklemmen und Sense-Verbindungen sicherzustellen.

Die standardmäßigen LAN-, USB- und Interlock-Verbinder sowie optionale Schnittstellen sind auf Erdpotential und können als sicher angesehen werden, wenn die 'minus' DC-Anschlussklemme des Geräts im Verhältnis zur Erdung 1000 VDC/707 Vpk nicht überschreitet für SM70-CP-450, SM210-CP-150 und SM500-CP-90, oder 1500VDC / 1060Vpk im Verhältnis zur PE für SM1500-CP-30.

Vorsicht 1: Falls beide DC-Anschlussklemmen eines Niederspannungsgerätes potentialfrei sind oder falls die DC-Klemmen in Reihe mit einer externen AC- oder DC-Hochspannung geschaltet sind, kann die 'minus' DC-DC-Anschlussklemme den sicheren Wert in Bezug auf die Erdung wie in der Warnung oben spezifiziert überschreiten.

Vorsicht 2: Obwohl ein Hochspannungsgerät mit einer sicheren Spannung unter 60 VDC betrieben wird, muss es zur Sicherheit immer als Hochspannungsgerät angesehen werden! Falsche Bedienung, ein Programmierfehler oder ein externer Fehler können zu einer unsicheren, hohen DC-Ausgangsspannung führen. Für weitere Informationen und Schaltpläne hinsichtlich Erdung und Sicherheit, siehe den online Applikationshinweis 'Safe operation of a power supply'.

2.5 Gefahr eines elektrischen Schlags

Das Berühren der Kontakte des Netzsteckers oder der Kabel direkt nach der Trennung vom Netz kann zu einem elektrischen Schlag führen. Und aufgrund von geladenen X-Kondensatoren, kann gefährliches Potential zwischen 'plus' oder 'minus' DC-Anschlussklemme und PE bestehen oder entstehen. Auch wenn die DC-Anschlussklemmen ausgeschaltet sind, aber das Gerät noch eingeschaltet ist. Daher niemals gleichzeitig PE und einen der DC-Anschlussklemmen berühren mit bloßen Händen.

2.6 Verbindung mit dem Versorgungsnetz

Entweder permanent mit dem Versorgungsnetz verbinden oder via einer Industriesteckverbindung entsprechend IEC 60309. „Permanent verbundene Ausrüstung“ oder „Steckbare Ausrüstung Typ B“.

2.7 Sicherungen

Sicherungen dürfen ausschließlich von autorisiertem Delta Elektronika-Service-Personal ausgetauscht werden, um Brandgefahr dauerhaft auszuschließen.

2.8 AC-Eingangsleistung

Verwenden Sie keine AC-Versorgung, welche die AC-Eingangsspannung und Frequenzleistung dieses Geräts überschreitet. Die AC-Eingangsspannung und Frequenzleistung der Delta Elektronika-Stromversorgungsserie sind im beiliegenden Datenblatt angegeben.

2.9 Spannungsführenden Stromkreise

Bedienungspersonal darf die Geräteabdeckungen nicht entfernen. Interne Einstellungen oder Bauteilaustausche sind ausschließlich qualifiziertem Personal von Delta Elektronika gestattet. Bauteile nie bei eingestecktem Stromkabel austauschen. Um Verletzungen zu vermeiden, vor dem Berühren von Bauteilen immer den Strom trennen, externe Spannungsquellen entfernen und Stromkreise entladen.

2.10 Teileaustausch & Modifikationen

Teileaustausch und Modifikationen sind ausschließlich autorisiertem Delta Elektronika-Service-Personal gestattet. Reparaturen am Gerät dürfen nur durch eine Delta Elektronika-Serviceeinrichtung durchgeführt werden.

2.11 Entfernung von (Sicherheits-) Abdeckungen

Sicherheitsabdeckung(en) werden verwendet, um potenziell gefährliche Spannungen abzudecken. Beachten Sie Folgendes, wenn Sie die Sicherheitsabdeckung(en) entfernen:

- Gerät ausschalten, Gerät von dem AC-Versorgungsnetz und DC-Anwendung trennen.
- Warten Sie 5 Minuten um interne Kondensatoren zu entladen. Abschrauben und entfernen von Abdeckung(en).
- Bevor Sie das Gerät wieder mit dem Versorgungsnetz verbinden, montieren Sie vorher jedes Mal die Abdeckung(en).

2.12 Handhabung und Montage

Warnung! Einheit Gewicht ist 27kg! Beim Auspacken oder Umziehen vorsichtshalber: Heben Sie mit 2 Personen an oder benutzen Sie ein Liftwerkzeug. Gefahr der Zerkleinerung der Gliedmaßen unter Einheit. Risiko des Schneidens: Einheit hat scharfe Kanten und Ecken!

Warnung! Keine Wandmontage oder Deckenmontage erlaubt! Gefahr der Zerkleinerung unter Einheit. Nur Einheit horizontal montieren, auf eine stabile Oberfläche stellen oder Rack-Montage verwenden.

2.13 Rotierender Lüfter, thermischer Verbrennung

Für die Kühlung des Geräts ist ein richtiger Luftstrom erforderlich. Dies ermöglicht den Betrieb bei voller Leistung und einer längeren Lebensdauer. Wenn das Gerät überhitzt wird, schaltet sich die Stromversorgung herunter, bis das Gerät wieder abgekühlt ist.

Warnung! Top-Abdeckung und Lüfter Auspuffs können heiß werden. Vermeiden Sie diese zu berühren, während Sie das Gerät mit hoher Leistung bedienen!

Warnung! Blockieren Sie keine Lüfter Öffnungen oder Luftabsaugungen. Versuchen Sie nicht, Lüfter Öffnungen durch ein Objekt zu betreten, um Lüfter zu behindern. Lange Haare können in Ventilator stecken bleiben, tragen Sie ein Haarnetz, wenn Sie lange Haare haben.

Warnung! Schließen Sie keine Kabel an die DC-Anschlussklemmen an, während das Gerät eingeschaltet ist. Plötzliches Machen oder Brechen von hohen Gleichstrom kann große Funken verursachen, auch bei niedriger Spannung. Gefahr von thermischen Verbrennung und Feuer!

2.14 Elektromedizinische Geräte

Warnung! Hohe Ströme können durch die DC-Anschlussklemmen laufen. Diese Ströme verursachen starke Magnetfelder. Kommen Sie nicht in die Nähe, wenn Sie ein elektromedizinisches Gerät wie einen Herzschrittmacher haben.

2.15 Umgebungsbedingungen

Die Stromversorgungssicherheitszulassung von Delta Elektronika gilt für die folgenden Betriebsbedingungen:

- Gebrauch : Nur Innengebrauch. **Warnung!** Nicht für die Verwendung in Gegenwart von Kindern oder Tieren vorgesehen!
- Umgebungstemperatur : -20 bis 50 °C.
- Maximale relative Luftfeuchtigkeit : 95%, nicht kondensierend, bis zu 40 °C, 75%, nicht kondensierend, bis zu 50 °C
- Höhe : Nicht über 2000 m Meeresspiegel verwenden.
Warnung! Elektrische Creepage & Clearance nicht gültig für größere Höhen!
- Verschmutzungsgrad : 2

2.16 Symbole und Markierungen



Vorsichtsgefahr bei elektrischen Schlag.



PE-leiterklemme.



Bedienungsanleitung Symbol. Das Gerät wird mit diesem Symbol gekennzeichnet, wenn der Benutzer auf die Bedienungsanleitung verweisen muss.



Aus (Versorgungsnetz).



Ein (Versorgungsnetz).

WEEE (Waste Electrical & Electronic Equipment)

2.17 Korrekte Entsorgung dieses Produkts

Anwendbar in der Europäischen Union.



Diese Kennzeichnung auf dem Produkt, seiner Verpackung oder seiner Literatur weist darauf hin, dass es am Ende seiner Lebensdauer nicht mit anderen Abfällen entsorgt, sondern separat gesammelt werden sollte, um es verantwortungsvoll zu recyceln, um die nachhaltige Wiederverwendung von Material zu fördern.

3 CONSIGNES DE SÉCURITÉ - Série SM15K

3.1 Mise en garde

Les précautions de sécurité suivantes doivent être suivies dans toutes les phases de fonctionnement, d'entretien et de réparation de cet appareil. Le non-respect des précautions de sécurité ou des avertissements contenus dans le présent document enfreint les normes de sécurité concernant la conception, la production et l'utilisation prévue de cet appareil et peut endommager les dispositifs de protection intégrés. Delta Elektronika n'est pas responsable si l'utilisateur ne se conforme pas à ces exigences.

3.2 Catégorie d'installation

Les alimentations de Delta Elektronika ont été affectées à la catégorie d'installation II (catégorie de surtension II).

3.3 Mise à la terre des bornes de raccordement secteur (bornes d'alimentation CA)

Ce produit est un appareil de classe 1. Pour minimiser le risque de choc électrique, l'appareil doit être connecté au réseau d'alimentation CA à l'aide d'un câble d'alimentation à quatre fils. Dans ce cas, le conducteur de protection doit être fermement connecté à une connexion de mise à la terre électrique (conducteur de protection) à la source d'alimentation. Pour les appareils câblés au réseau d'alimentation, la borne de mise à la terre de protection doit être connectée au connecteur de mise à la terre de sécurité avant d'effectuer une autre connexion. Une interruption du conducteur de protection ou une séparation de la pince de mise à la terre de protection peut entraîner un choc électrique pouvant blesser les personnes.

3.4 Mise à la terre des bornes CC

Si la borne CC d'un appareil est conçue pour recevoir ou obtenir un maximum de 60 VDC et que la borne CC 'moins' ou 'plus' est mise à la terre, la tension sur les bornes CC et les connexions de circuit de lecture (marque 'Sense') peuvent être considérées comme sûres.

Attention! Si le bornier CC 'plus' peut dépasser 60 VDC par rapport au bornier CC 'moins', des mesures externes supplémentaires doivent être prises pour assurer l'isolation de sécurité des bornes CC et des connexions de circuit de lecture (marque 'Sense').

Attention! Si le bornier CC 'moins' peut dépasser 60 VDC/42,4 Vpk par rapport à la mise à la terre, des mesures externes supplémentaires doivent être prises pour assurer l'isolation de sécurité des bornes CC et des connexions de circuit de lecture (marque 'Sense').

Les connecteurs LAN, USB et de verrouillage standard ainsi que les interfaces optionnelles sont à leur potentiel de mise à la terre et peuvent être considérés comme sûrs si le terminal CC 'moins' de l'appareil par rapport à la mise à la terre ne dépasse pas 1000 VDC / 707 Vpk pour SM70-CP-450, SM210-CP-150 et SM500-CP-90, ou 1500VDC / 1060Vpk par rapport à PE pour SM1500-CP-30.

Attention 1 : Si les deux bornes CC d'un dispositif basse tension sont sans potentiel ou si les bornes CC sont connectées en série avec une haute tension EXTERNE CA ou CC, le bornier CC-CC 'moins' peut dépasser la valeur de sécurité en termes de mise à la terre comme spécifié dans l'avertissement ci-dessus.

Attention 2: Bien qu'un appareil haute tension fonctionne à une tension de sécurité inférieure à 60 VDC, il doit toujours être considéré comme un appareil haute tension pour la sécurité! Un fonctionnement incorrect, une erreur de programmation ou une erreur externe peut entraîner une tension de sortie CC incertaine et élevée. Pour plus d'informations et des schémas de circuit concernant la mise à la terre et la sécurité, voir la note d'application en ligne '*Fonctionnement sûr d'une alimentation électrique*'.

3.5 Risque de choc électrique

Toucher les contacts de la fiche d'alimentation ou des câbles immédiatement après la déconnexion du secteur peut entraîner un choc électrique. Et en raison des condensateurs X chargés, un potentiel dangereux entre le terminal CC 'plus' ou 'moins' et le PE peut exister ou survenir. Même si les bornes CC sont éteintes, mais que l'appareil est toujours allumé. Par conséquent, ne touchez jamais PE et l'un des terminaux DC à mains nues en même temps.

3.6 Connexion au réseau d'alimentation

Connectez-vous en permanence au réseau d'alimentation ou via une connexion de prise industrielle conformément à la norme CEI 60309. 'Équipement connecté en permanence' ou 'Équipement enfichable de type B'.

3.7 Fusibles

Les fusibles ne peuvent être remplacés que par le personnel de service autorisé de Delta Elektronika afin d'éliminer définitivement le risque d'incendie.

3.8 Alimentation d'entrée CA

N'utilisez pas une alimentation CA qui dépasse la tension d'entrée CA et la puissance de fréquence de cet appareil. La tension d'entrée CA et la puissance de fréquence de la série d'alimentations Delta Elektronika sont spécifiées dans la fiche technique ci-jointe.

3.9 Circuits en direct

Les opérateurs ne doivent pas retirer les couvercles de l'appareil. Les réglages internes ou les remplacements de composants ne sont autorisés qu'au personnel qualifié de Delta Elektronika. Ne remplacez jamais les composants par le câble d'alimentation branché. Pour éviter les blessures, débranchez toujours le courant avant de toucher les composants, retirez les sources de tension externes et les circuits de décharge.

3.10 Remplacement et modifications des pièces

Le remplacement et les modifications des pièces ne sont autorisés qu'au personnel de service autorisé de Delta Elektronika. Les réparations de l'appareil ne peuvent être effectuées que par un centre de service Delta Elektronika.

3.11 Retrait des couvercles (de sécurité)

Les couvercles de sécurité sont utilisés pour couvrir les tensions potentiellement dangereuses. Gardez les points suivants à l'esprit lorsque vous retirez le(s) couvercle(s) de sécurité :

- Éteignez l'appareil, déconnectez-le du réseau d'alimentation CA et de l'application CC.
- Attendez 5 minutes pour décharger les condensateurs internes. Dévissez et retirez-le(s) couvercle(s).
- Avant de reconnecter l'appareil au réseau d'alimentation, installez-le(s) couvercle(s) à chaque fois.

3.12 Manipulation et assemblage

Attention! Le poids unitaire est de 27 kg! Lors du déballage ou du changement par précaution: Soulevez avec 2 personnes ou utilisez un outil de levage. Danger d'écraser les membres sous l'unité. Risque de coupe: L'unité a des arêtes vives et des coins!

Attention! Aucun montage mural ou au plafond n'est autorisé! Danger d'écrasement sous l'unité. Montez uniquement l'unité horizontalement, placez-la sur une surface stable ou utilisez un support en rack.

3.13 Ventilateur rotatif, combustion thermique

Un flux d'air approprié est nécessaire pour refroidir l'appareil. Cela permet un fonctionnement à pleine puissance et une durée de vie plus longue. Si l'appareil surchauffe, l'alimentation s'éteindra jusqu'à ce que l'appareil ait refroidi à nouveau.

Attention! Le couvercle supérieur et les échappements du ventilateur peuvent devenir chauds. Évitez de les toucher lorsque vous utilisez l'appareil avec une puissance élevée!

Attention! Ne bloquez pas les ouvertures des ventilateurs ou les bouches d'aération. N'essayez pas d'entrer dans les ouvertures des ventilateurs à travers un objet pour obstruer les ventilateurs. Les cheveux longs peuvent rester coincés dans un ventilateur, portez un filet à cheveux si vous avez les cheveux longs.

Attention! Ne connectez pas de câbles aux bornes CC lorsque l'appareil est allumé.

Soudain, faire ou casser un courant continu élevé peut provoquer de grandes étincelles, même à basse tension. Danger de combustion thermique et d'incendie!

3.14 Équipement électromédical

Attention! Des courants élevés peuvent traverser les bornes CC. Ces courants provoquent de forts champs magnétiques. Ne vous approchez pas si vous avez un appareil électromédical comme un stimulateur cardiaque.

3.15 Conditions ambiantes

L'approbation de sécurité de l'alimentation de Delta Elektronika s'applique aux conditions de fonctionnement suivantes :

- Utilisation : Utilisation à l'intérieur seulement. **Attention!** Non destiné à être utilisé en présence d'enfants ou d'animaux!
- Température ambiante : -20 à 50 °C.
- Humidité relative max: 95%, sans condensation, jusqu'à 40 °C, 75 %, sans condensation, jusqu'à 50 °C
- Altitude: Ne pas utiliser au-dessus de 2000 m niveau de la mer.
Attention! Creepage & Clearance électrique non valable pour les altitudes plus élevées!
- Degré de contamination: 2

3.16 Symboles et marqueurs



Risque de prudence en cas de choc électrique.



Terminal conducteur de terre de protection.



Icône du manuel d'instructions. L'appareil est marqué de cette icône lorsque l'utilisateur doit se référer au manuel d'instructions.



Désactivé (réseau d'approvisionnement).



A (réseau d'approvisionnement).

DEEE (Déchets d'équipements électriques et électroniques)

3.17 Élimination correcte de ce produit

Applicable dans l'Union européenne.



Cet étiquetage sur le produit, son emballage ou sa documentation indique qu'il ne doit pas être éliminé avec d'autres déchets en fin de vie, mais doit être collecté séparément afin de le recycler de manière responsable afin de promouvoir la réutilisation durable des matériaux.

4 QUICK START - SM15K-series

4.1 Connecting the unit

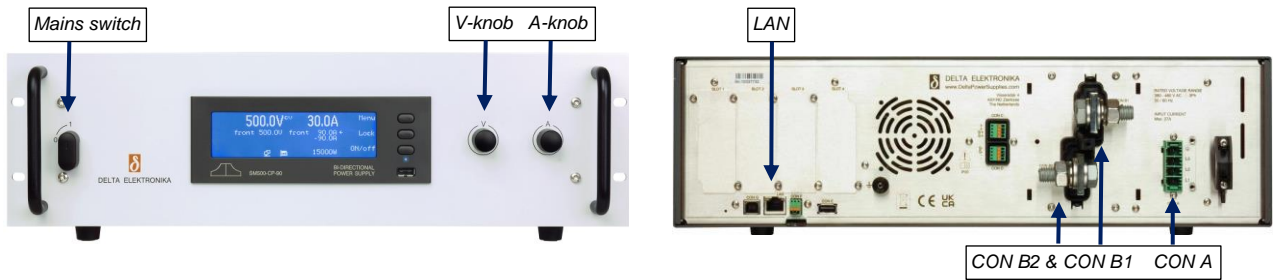

fig 4 - 1 - controls and connections.

Warning! Never make connections to the Power Inputs, Power Outputs or Sense Connector when the unit is connected to the mains supply or power outlet! Safety covers are used to cover these in- and outputs. Carefully read the chapter "Safety Instructions" in this manual before connecting or operating the unit!

Warning! Some components inside the power supply are at AC voltage even when the On/Off switch is in the off position. Therefore, a readily accessible, appropriately rated, disconnect device shall be incorporated external to the equipment. The power supply shall be connected to the mains supply via a protection device with a rating of maximum 32A. For example, a circuit breaker or fuses etc.

4.1.1 AC POWER TERMINALS (AC-MAINS)

- This connector is located at the rear side, marked as CON A.
- Use a cable with a diameter of 4 mm² for each wire and a sufficient voltage rating for the AC input voltage of the unit.
- Use the included 4-pole header with the markings L1, L2, L3, PE for connecting the wire to the unit (see fig. 4 - 1).
- The mounting torque for the header terminals is 0.6 Nm.
- Always connect the PE terminal to the Protective Earth, no neutral connection is required.
- The unit can operate only on a 3-phase grid, with a rated voltage of 380...480VAC.
- After installation, connect the pull relief and add the safety cover over the AC terminals.

4.1.2 DC POWER TERMINALS

- These terminals are located at the rear side, marked as CON B1 (PLUS) and CON B2 (MINUS), see fig. 4 - 1.
- See table 4 - 1 at this page for the correct cable diameter and mounting torque. Use cables with a sufficient voltage rating for the maximum output voltage of the unit.
- With high output current, use low resistive connections between the power supply and the load:
 - Mount the cable lugs directly on the DC power strips followed by a washer, a split washer and a nut. Always in this order!
 - Never place washers between the lugs and the strips because this can result in excessive heat!
 - Only use nuts and washers supplied with the unit.
- The DC power terminals are floating in relation to Protective Earth.
- After installation mount the safety cover over the DC power terminals.

Unit	DC Output cable [mm ²]	Bolts	Torque [Nm]
SM70-CP-450	150	M12	80
SM210-CP-150	50	M12	80
SM500-CP-90	35	M8	20
SM1500-CP-30	6	M8	20

table 4 - 1
Recommended cable diameters and mounting torque.

4.1.3 LAN-CONNECTOR

- Insert a standard RJ45 network cable to the LAN-connector at the rear side, see fig. 4 - 1 and make connection to a Local Area Network (LAN) to perform a firmware update and use the units' web browser, see next paragraph.
- The LAN-connector is at Protective Earth level.

4.1.4 LOAD SENSING, INTERLOCK, USB, INTERFACES, SERIES-PARALLEL, MASTER/SLAVE

- Refer to user manual for connecting and using these features and options.

4.2 Operating the unit

4.2.1 FIRMWARE UPDATE

- Switch the unit on by rotating the mains switch on the front panel clockwise.
- In the unit menu, check the firmware revision via Menu > System > info > Unit > Version. Use the V- and A-knob to navigate through the menu.
- On a computer, check at if there is new firmware available via: [Products > SM15K > Downloads](#).
- If newer, download the firmware package to the computer and connect this to the same LAN as the unit.
- In the unit menu, check the IP-address via Menu > Interfaces > LAN > Address*.
- On the computer, open the SM15K web interface using an internet browser by entering the IP-address of the unit in the address bar of the browser.
- In the web interface, go to Administration > Firmware.
- Select "Choose File" and browse to the downloaded package, enter password and "Start Update".

*Note: when DHCP is enabled, the IP-address can change, for example after a power cycle.

4.2.2 FIRST OPERATION

- The first line in the front display indicates the actual output voltage and current. The second line shows the settings of the controls.
- Check the text 'front' is indicated - this means the unit is in local-operation and can be controlled by the V-knob and A-knob at the front panel.
- Switch the output on by pressing the on/OFF button.
- Turn the V- and A-knob a half turn clockwise. Depending on the load, a voltage should now be present on the output and a current will run through the load.
- Depending on the load and settings, the unit will be either in constant voltage, current or power mode, respectively CV-, CC- or CP-mode.
- Respectively the indication 'CV' will appear on the first line, next to the actual voltage value. The indication 'CC' will appear next to the actual current value or 'CP' will appear next to the actual power value.

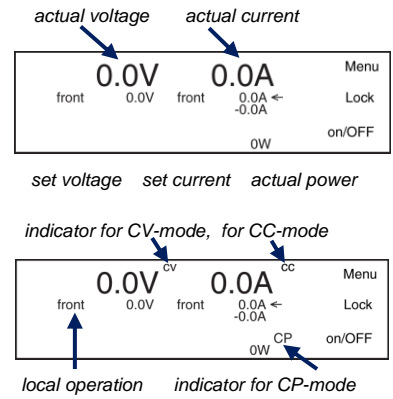

fig 4 - 2 - start up settings.

4.2.3 SOURCE & SINK CURRENT

- By default, the A-knob at the front sets the source current 'CC+'.
- By pressing the buttons 'Lock' and 'Menu' simultaneously, the function of the A-knob changes from 'CC+' to 'CC-', to set the sink current.
- In the display the arrow behind the value for the current changes position, see fig 4 - 3.

4.2.4 SOURCE & SINK POWER

- Set the maximum power via Menu > Configuration > Prg Setting > Psettings.
- Here rotate the V-knob to set the source power from 0...15kW.
- This is the power the unit can deliver to the DC power terminals.
- Rotate the A-knob to set the sink power from 0...-15kW.
- This is the power the unit can absorb from the DC power terminals and feed back into the grid.

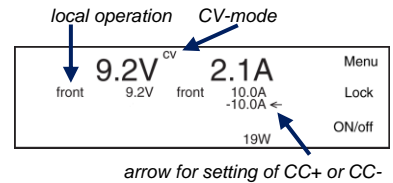

fig 4 - 3 - 19 W output power.

4.2.5 LIMITATION OF SETTINGS

- By default, the settings for CV, CC and CP Limit are set to the maximum.
- Change the limit settings via Menu > Protection > Limits.

4.2.6 REMOTE PROGRAMMING

- By default, a unit is in local operation, see fig. 4 - 3.
- In remote operation different programming options are available such as 'eth', 'web', 'seq', 'slot1', etc.
- Via the front menu the source can be set to the required programming input via: Menu > Configuration > Source.
- When connected to LAN, enter the unit's IP-address in a web browser to open the web interface.
- With this interface all above-described parameters plus additional parameters can be set and read.
- For more information, see the chapter Remote Programming of the user manual.

4.3 Download User Manual

4.3.1 FULL VERSION

Check at www.DeltaPowerSupplies.com for the full version of the user manual via: **Products > SM15K > Downloads.**

4.4 Driver & Example Software

4.4.1 APPLICATIONS & INTERFACES

- Check at www.DeltaPowerSupplies.com for driver and example software via: **Products > SM15K > Downloads.**

Note:

It is strongly recommended to regularly check for updates for additional functionality and improvements.

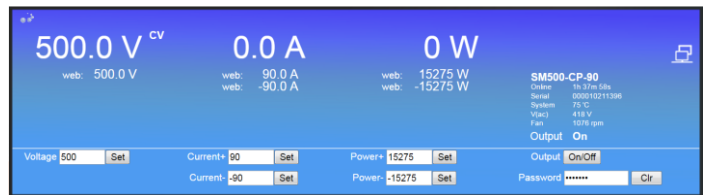

fig 4 - 4 - The front console of the web interface for setting of the output and monitoring various parameters.

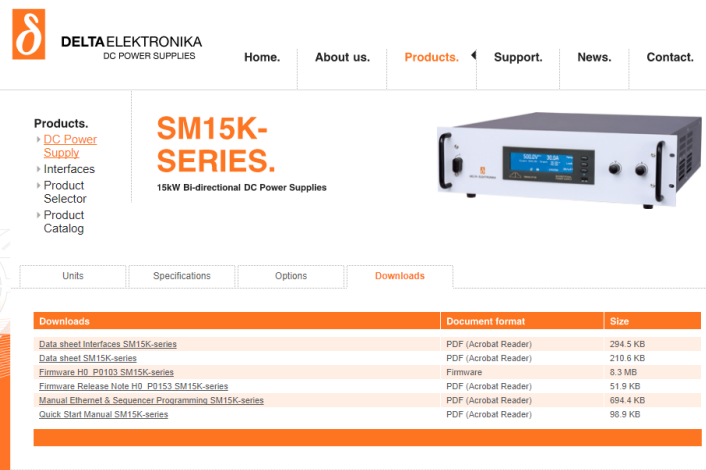

fig 4 - 5 - Regularly check for new versions of user manual and firmware.

5 GENERAL

5.1 DC OUTPUT

- The SM70-CP-450, SM210-CP-150, SM500-CP-90 and SM1500-CP-30 can either be used as a constant voltage sink and source with current or power limit, or as a constant current sink and source with voltage or power limit.
- The change of mode occurs at the crossing of the voltage, current and power settings. Fig. 5 - 1 shows the output ranges.

5.2 BI-DIRECTIONAL OPERATION

- The unit operates in source or sink mode and changes over between modes depending on the settings and the load conditions at the DC power terminals.
- **Warning!** When using the unit as a load, the user needs to take care the voltage of the source connected to the DC power terminals is not exceeding the maximum allowed voltage, a too high voltage or overshoot can damage the unit.
- Note that the inductance (like cable inductance) in series with a voltage source can cause a voltage overshoot at the DC power terminals, when switching the output from "ON" to "OFF" or switching off the mains.
- Via the user menu the amounts of sink power and source power can be set between 15kW and almost zero independently from each other.

5.3 CONSTANT POWER MODE

- Both in Source and in Sink mode, the unit can operate in Constant Power mode.
- The user can select any value between the maximum power and zero watts separately for source and sink mode depending on the DC load and mains supply.

5.4 OVERLOAD PROTECTION

- **Warning!** The output can be damaged by voltage overload.
- The power supply is fully protected against all overload conditions, except connecting a voltage source, exceeding the maximum allowed voltage, to the DC power terminals.
- The display indicates OL in case of a voltage overload of 102.5% or more.
- The DC power terminals automatically disable at a voltage overload of 105% or more, the display indicates PROT.

5.5 AC INPUT VOLTAGE

- The power supply works on a three phase AC mains voltage and has a wide voltage range.
- No neutral connection is required.
- In case of a low AC voltage or missing phase, the AC-Fail status will be high.

5.6 AC INPUT CURRENT

- The unit has active power factor correction (PFC). The AC input current will therefore almost be a sine wave. This means that the RMS-value and the harmonic distortion of the AC input current will be relatively low.

5.7 AC INPUT POWER WITH DC OUTPUT OFF

- The unit consumes little power when the DC output is switched off. This makes it possible to leave the AC input powered on when the DC output is disabled by the Output On/Off function.
- The DC output can be switched On/Off via a push button on the front panel or by remote programming.

5.8 TURN ON DELAY

- The DC output voltage is available quickly after mains switch on.
- The exact specifications can be found in the datasheet.

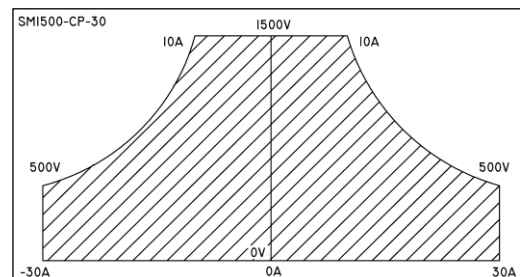
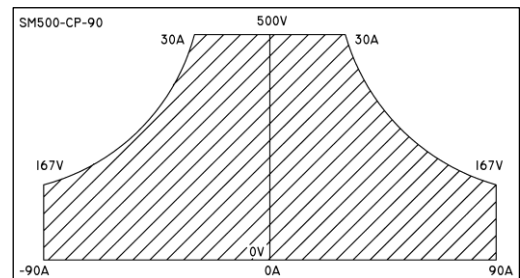
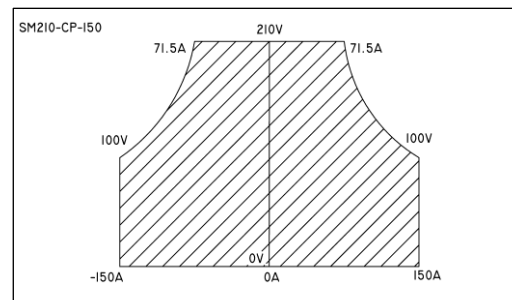
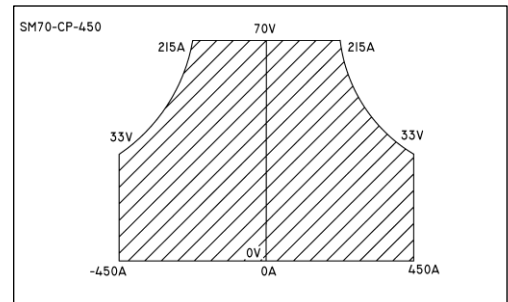

fig 5 - 1
DC Output voltages and currents.
Every point in hatched area can be used.

5.9 INRUSH CURRENT

- The AC inrush current is electronically limited. Repeatedly switching on and off does not change the maximum peak current.
- Switching on and off at a fast rate can overheat the inrush current limiter with the result that the unit does not start anymore. After cooling down (mains switched off) it will start up again.

5.10 EFFICIENCY

- The efficiency is very high and constant over a wide DC sink and source range. High efficiency means low power losses and little heat generation.

5.11 RIPPLE & NOISE

- The DC output ripple is very low with almost no spikes. At low temperatures like -20°C the ripple increases. By using high quality electrolytic capacitors the increase is kept to a minimum.

5.12 RFI SUPPRESSION

- Both the input and output have RFI filters, resulting in very low conducted RFI to the line and load. Due to the output filter the output voltage is very clean, having almost no spikes.

5.13 ROTARY ENCODERS

- Digital encoders for CV and CC setting with a very long life time and intelligent functions (e.g. Keylock, variable pitch).
- Via the menu also the CP setting is done with these encoders.
- The encoders are also used for scrolling through the menu (see fig. 5 - 2).

5.14 LIMIT FOR VOLTAGE, CURRENT and POWER

- The Voltage Limit will protect your circuit from unwanted high voltages. A high DC output voltage could be caused by accidental interruption of leads, accidentally turning up the voltage setting, a programming error or a defect in the system.
- The Current+ and Current- Limits protect your circuit from unwanted high DC source and sink currents.
- The Power+ and Power- Limits protect your circuit from unwanted high sink or source power.
- The Limits maintain the output to a safe preset value. They do not trip, so no resetting is needed after a fault.

5.15 HOLD - UP TIME

- The hold - up time depends on the DC load and the DC output voltage. A lighter load or a lower output voltage result in a longer hold - up time (see fig. 5 - 3).

5.16 REMOTE SENSING

- The DC voltage at the load can be kept constant by remote sensing. This feature should only be used when the load voltage is not allowed to vary a few millivolts.
- In order to compensate for the voltage-drop across the load leads, the unit will have to supply a higher voltage (see fig. 5 - 4).
- The sense leads are protected against accidental interruption.

5.17 SERIES OPERATION

- The power supplies can be connected in series without special precautions. For the maximum allowed series voltage, see chapter 'Installation'.
- **Warning!** Note that the unit has internally an anti-parallel diode connected to the DC power terminals, this diode can get overheated when a larger negative current flows through the output with the output switched to "OFF", or the mains switched off.
- This can typically happen with units in series, where one unit has the output switched to "OFF". To avoid overheating of the

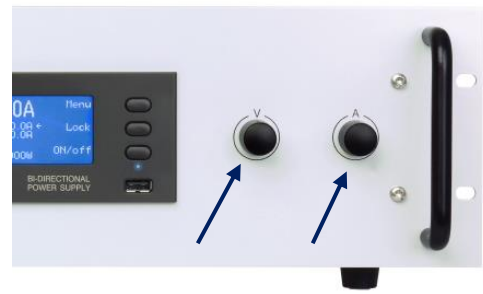

fig 5 - 2
Digital rotary encoders for voltage and current setting and for menu operation.

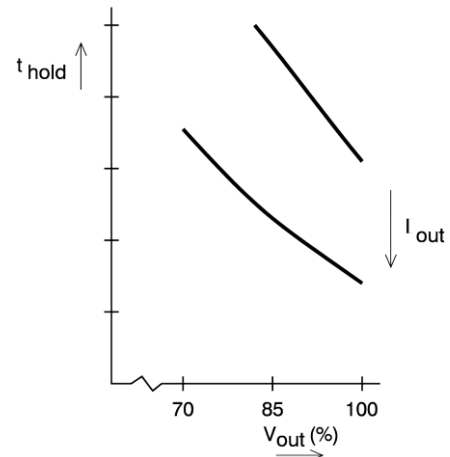

fig 5 - 3
Hold-up time vs. V_{out} with I_{out} as a parameter.

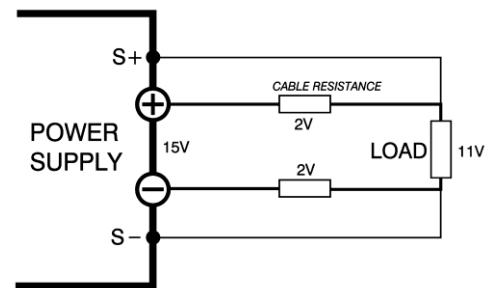

fig 5 - 4
Remote sensing, voltage drop in load leads subtracts from maximum DC output.

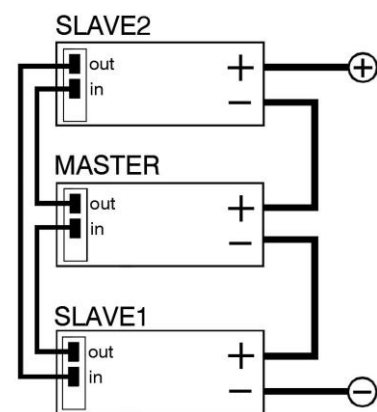

fig 5 - 5
Optional Master / Slave series operation.

diode take care the output is switched to “ON” and the negative current setting is sufficient to hold the current.

- For easier control, the optional Master/Slave interface is recommended (see fig. 5 - 5).

5.18 PARALLEL OPERATION

- Without Master/Slave interface, only one unit can operate in the Bi-Directional mode, all others can only be used as power source.
- With the optional Master/Slave interface (see fig. 5 - 6) the power supplies can be connected in parallel without limitations and with full functionality.

5.19 INTERLOCK

- The Interlock connector at the rear panel has two pins which have to be connected together to turn on the DC power terminals of the unit.
- As soon as the link between the 2 outer pins of the Interlock connector is interrupted, the DC power output of the unit shuts down.
- It can be used in combination with a cabinet door contact (safety precaution) or as an emergency brake to stop a motor which is powered by the unit. Once the interlock pins are connected again, the DC power output will be on.

5.20 WEB INTERFACE, ETH & USB PROGRAMMING

- The web interface and Ethernet are standard available on all units via the LAN connector at the rear side.
- Also, a USB connector is standard available but USB programming is still under development for firmware version P0170.
- The web interface can be used to view and change the settings for CV, CC+, CC-, POWER+, POWER-, Output On/Off, configure the sink mode or optional interfaces, to upload new firmware and configure the unit similar as with the front display menu.
- With the build-in Ethernet interface it is possible to program the CV/CC/CP-settings, to read the CV/CC-monitors and the status signals.

5.21 SEQUENCER PROGRAMMING

- Possibility to use the unit in stand-alone automation or use as an arbitrary waveform generator and create loops, ramps etc.
- The sequencer can be controlled via the web interface and via Ethernet programming.

5.22 FUNCTION BLOCKS

- With the new SM15K series Delta introduces “Integrated Function Blocks”.
- Integrated Function Blocks are functional integrated software blocks with predefined behavior that can be put in between a program source and the units output controllers, see fig. 5 - 7.
- By using these Integrated Function Blocks the user is able to manipulate the units Program sources or can setup specific simulations.
- See "Function Blocks Manual" for more information and examples.

5.22.1 LEADLESS SENSING

- The Integrated Function Block “Leadless sensing” is a functional integrated software block with predefined behavior that can be put in between a program source and the units output controllers.
- By using this Integrated Function Block the user is able to compensate a voltage drop falling over long or high resistive load cables.

5.22.2 INTERNAL RESISTANCE

- The Integrated Function Block “Internal Resistance” is a functional integrated software block with predefined behavior that can be put in between a program source and the units output controllers.

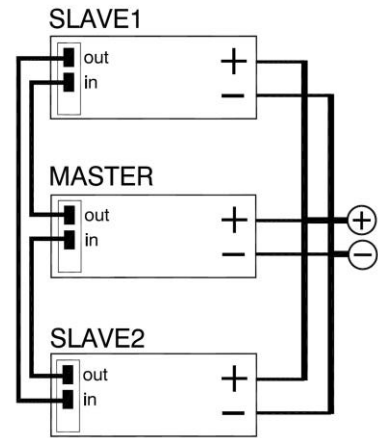

fig 5 - 6
Optional Master/slave parallel operation.

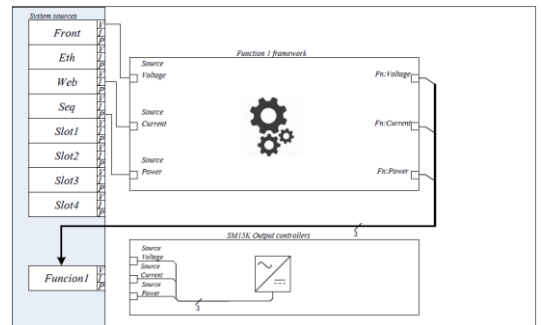

fig 5 - 7
Functions Blocks can be put in between a program source and the units output controllers.



fig 5 - 8
Different interface modules can be plugged in.

- By using this Integrated Function Block, the user is able to simulate a voltage drop falling over a virtual internal resistance.

5.22.3 PHOTOVOLTAIC SIMULATION

- The Integrated Function Block "PhotoVoltaic Simulation" is a functional integrated software block with predefined behavior that simulates PV-operation.

5.23 OPTIONAL INTERFACES

- Up to a number of 4 interfaces can be plugged in the sockets at the rear side of the unit (see fig. 5 - 8).
- All interfaces can easily be plugged in afterwards at the customer site.
- The following types are available:
 - Master/Slave controller (=INT MOD M/S-2).
 - Serial, USB and differential programming (=INT MOD SER).
 - Digital User I/O for programming (=INT MOD DIG).
 - Floating Contacts, floating Interlock and floating Enable (= INT MOD CON).
 - Isolated analog programming & monitoring, logic status outputs.

5.24 PROGRAMMING SPEED

- The specified rise and fall times are measured with a step waveform using the internal sequencer.
- Up and down programming is nearly load independent.

5.25 COOLING

- Three low noise blowers cool the unit. The speed of the fans depends on the temperature of the internal heatsinks (see fig. 5 - 9). Normally, at 50 °C ambient and full load the fans will not work at full speed.
- Due to the air that enters on the left and exits on the right, it is possible to stack the power supplies. No distance between the units is required.

5.26 OPERATING TEMPERATURE

- At full power, the operating temperature range is -20 to +50 °C. From 50 to 60 °C the output current (either positive or negative) has to be derated linearly to 75% at 60 °C (see fig. 5 - 10). These temperatures hold for normal operation, i.e. the air intakes & air outlets on the left and right side must be free.

5.27 THERMAL PROTECTION

- A thermal protection circuit shuts down the output in case of insufficient cooling. The display will show a thermometer symbol and the OT-status will be active. After cooling down, the unit will start working again.

5.28 FIRMWARE UPDATING

- Regularly check for firmware updates at the Delta Elektronika website. If there is a new update available, the unit can be updated via the web interface.
- This document is based on firmware version P0170.

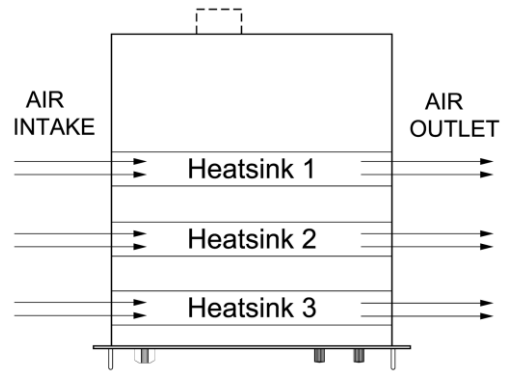

fig 5 - 9

The fans blow through the tunnels where the heatsinks are situated.

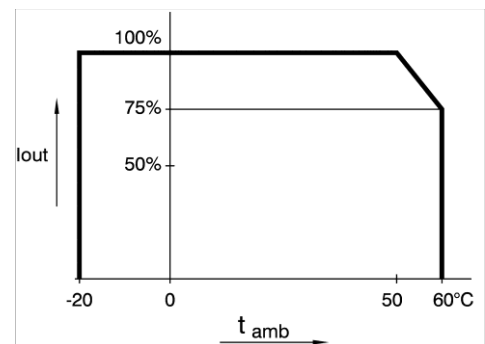

fig 5 - 10

Operating temperature ranges.

Note the current derating is the same for either sink or source mode.

6 INSTALLATION

- **Warning!** carefully read the chapter "Safety Instructions" in this manual before connecting or operating the unit!

6.1 HUMIDITY & CONDENSATION

- During normal operation, humidity will not harm the power supply, provided the air is not aggressive. The heat normally produced in the power supply will keep it dry.
- Avoid condensation inside the power supply, to prevent break-down. Condensation can occur during a period the power supply has been switched off (or operating at no load) and the ambient temperature is increasing. Always allow the power supply to dry before switching it on again.

6.2 TEMPERATURE & COOLING

- The storage temperature range is -40 to +85 °C.
- The operating temperature range at full load is -20 to +50 °C.
- This temperature range only holds when the air-intakes and air-outlets are unobstructed, and the temperature of the air-intake is not higher than +50 °C.
- When the power supply is mounted in a cabinet, please note that the temperature of the air-intake should be kept low and avoid a short circuit in the airflow i.e., the hot air leaving the air-outlets entering the air-intakes again.
- Please note: a lower temperature extends the lifetime of the power supply.

6.3 19" RACK MOUNTING

- On both sides in the rack, mount a proper support slide that can hold the weight of the unit. It is advised to use a separate slide for each unit.
- After placing the unit on the slide, add all 4 screws to mount the front panel of the power supply to the vertical rack posts. Use proper screws intended for keeping equipment of this weight in position.
- Assuming the rack is deliberately designed for the weight, stacking of the units is allowed without limitations. See previous paragraph for cooling instructions.

6.4 CONNECTING THE UNIT

- **Warning!** Never make connections to the Power Inputs and Outputs or the Sense Connector when the unit is connected to the mains supply or power outlet!
- Safety covers are used to cover these in- and outputs.
- Observe the following when removing a safety cover:
 - Switch off the unit.
 - Disconnect the unit from the mains supply.
 - Wait for 5 minutes to allow internal capacitors to discharge.
 - Unscrew the screws and remove the safety cover.
 - Place the safety cover back on the unit before connecting it to the mains supply again.
- **Warning!** Some components inside the power supply are at AC voltage even when the On/Off switch is in the off position. Therefore a readily accessible, appropriately rated, disconnect device shall be incorporated external to the equipment.

The power supply shall be connected to the mains supply via a protection device with a rating of maximum 32A.
For example a circuit breaker or fuses etc.

6.4.1 AC POWER TERMINALS (AC-MAINS)

- This connector is located at the rear side, marked as CON A.
- Use a cable with a diameter of 4 mm² for each wire. Use a cable with a sufficient voltage rating for the AC input voltage of the unit.
- Use the included 4-pole header with the markings L1, L2, L3 and PE for connecting the wire to the unit (see fig. 6 - 1). The mounting torque for the header terminals is 0.6 Nm.
- Always connect the PE terminal to the Protective Earth.

Unit	DC Output cable [mm ²]	Bolts	Torque [Nm]
SM70-CP-450	150	M12	80
SM210-CP-150	50	M12	80
SM500-CP-90	35	M8	20
SM1500-CP-30	5	M8	20

table 6 - 1

Recommended cable diameters and mounting torque.

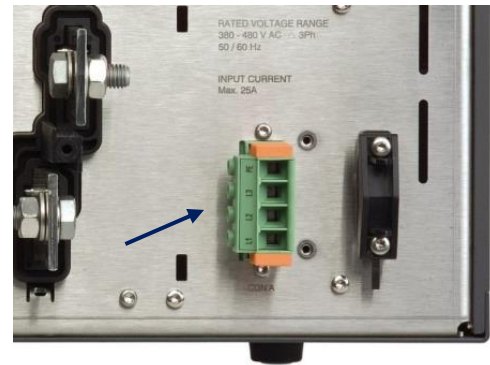

fig 6 - 1

Insert the included 4-pole header in CON A for the connection of the AC power / Mains.

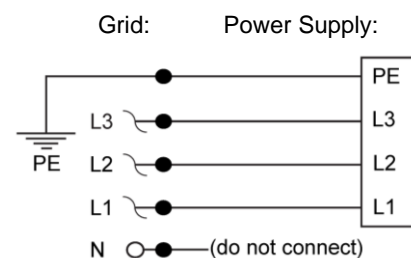

fig 6 - 2

The 3 phase connections for AC Mains.

- The unit can operate only on a 3-phase grid (see fig. 6 - 2), see the chapter 'Specifications' for the minimum and maximum values.
- No neutral connection is required.
- After installation, connect the pull relief and add the safety cover over the AC terminals.

6.4.2 DC POWER TERMINALS

- These terminals are located at the rear side, marked as CON B1 (PLUS) and CON B2 (MINUS) (see fig. 6 - 3).
- For cable diameters and mounting torque see table 6 - 1.
- Use cables with a sufficient voltage rating for the output voltage of the unit.
- With high output current, make sure to use low resistive connections between the power supply and the load:
 - Mount the cable lugs directly on the DC power strips followed by a washer, a split washer and a nut. Always in this order!
 - Never place washers between the lugs and the strips because this can result in excessive heat!
 - Only use nuts and washers supplied with the unit.
- Minimize the inductance in the leads by keeping them close to each other or by using a multi-strand cable.
- The DC power terminals are floating in relation to Protective Earth.
- After installation mount the safety cover over the DC power terminals.

6.4.3 DC LOAD SENSING (REMOTE SENSING)

- These connectors are located at the rear side, marked as CON C and CON D (see fig. 6 - 3).
- Use the included 4-pole headers for connecting the sense wires to the unit. By pressing the orange clips with a small screwdriver, the wires can be inserted or released.
- For local sensing, check whether there is a link between + and S+ and between - and S- on the sense header (default), see fig. 6 - 4.
- For remote sensing, please first read paragraph 6 of this chapter for more details.
- To use remote sensing, remove the links between + and S+ and - and S- and connect sense leads to the inputs for S+ and S-.
- The connectors enable the use of 2 sets of sense wires but one set is sufficient.
- Use cables with a diameter of 0.3 ... 0.5mm² and with a sufficient voltage rating for the DC output voltage of the unit.
- The leads are only thin measuring wires but always have to be shielded. In order to prevent interference, it is advisable to twist the leads. See fig. 6 - 5.
- With regards to safety, the sense terminals are at the level of the DC power terminals.
- After installation mount the safety cover over the sense terminals.

6.4.4 LAN-CONNECTOR

- This connector is located at the rear side, marked as LAN (see fig. 6 - 6).
- For Ethernet programming or Web Interface control, insert a standard RJ45 cable in the LAN connector at the rear side.
- With regards to safety, the LAN connector is at the level of Protective Earth.

6.4.5 INTERLOCK CONNECTOR

- This connector is located at the rear side, marked as CON F (see fig. 6 - 6).
- Use the included 3-pole header for connecting the interlock wires to the unit. By pressing the orange clips with a small screwdriver, the wires can be inserted or released.
- For more details and specifications about Interlock, please read paragraph 7 'Interlock Function' in this chapter.
- When the Interlock function is not used, connect a link between terminal 1 and 3 of the Interlock header (default).



fig 6 - 3
The two DC power terminals CON B1 and B2. Con C and D are the sensing connectors.

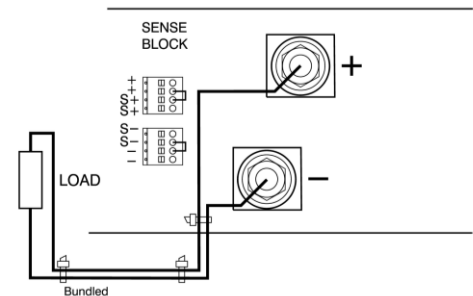

fig 6 - 4
Local sensing with the power cables bundled close together to minimize inductance.

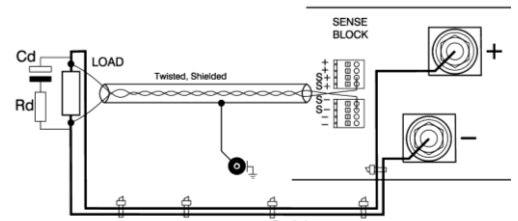

fig 6 - 5
Remote sensing with shielded twisted wires and the power cables bundled close together to minimize inductance.

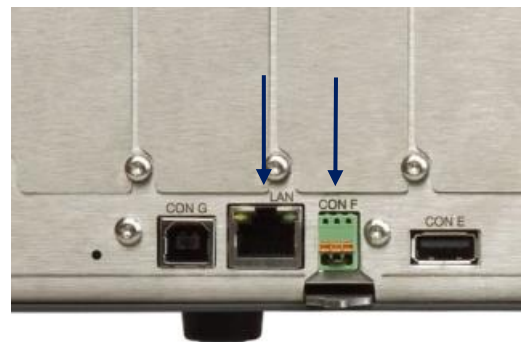

fig 6 - 6
The location of the LAN-connector (left) and the Interlock connector (right) at the rear panel.

- Use cables with a diameter of 0.3 ... 0.5mm² and with a sufficient voltage rating for the voltage of the circuit.
- With regards to safety, the Interlock connector is at the level of Protective Earth. For a floating Interlock contact, use the optional interface INT MOD CON.

6.4.6 USB-CONNECTORS

- With firmware version P0170, all USB-connectors are disabled.
- With regards to safety, all USB are at the level of Protective Earth.
- The type-A (Host) connectors are located at the front panel near the display, and one at the rear panel (CON E), see fig. 6 - 6 & fig. 6 - 7.
- The type-B (Device) is located at the rear panel (CON G), see fig. 6 - 6).
- The type-A connectors are meant for direct connection of flash drives for data exchange.
- The type-B connector is meant for controlling the unit. Use a cable which is maximum 3m in length.

6.4.7 OPTIONAL INTERFACES

- For programming via an optional interface, refer to the interface manual for installation and cable connections.

6.5 INSULATION

- The insulation of the separating components between input and output, such as transformers and opto-couplers, is tested before assembly during 1 minute @ 3750 Vrms (5300VDC) (see fig. 6 - 8).
- The insulation between the AC terminals and Protective Earth (3500VDC) and between DC terminals and PE (1000VDC or 1500VDC depending on unit model) is tested after assembly.
- Note1: the specified insulation between AC and DC terminals is tested at different stages during manufacturing. It cannot be tested afterwards on the assembled unit!
- Note2: when testing the insulation between the AC terminals and PE, or the DC terminals and PE, take care to charge and discharge the Y-capacitors slowly (e.g. in one second). This to prevent high peak currents, which could destroy the power supply. Make sure to discharge the Y-capacitors completely before using it again.

6.6 REMOTE SENSING

- **Warning!** This feature is not recommended for normal use, because damping is critical and wrong connection or routing can lead to instabilities.
- With remote sensing, the voltage on the load can be kept constant. The voltage drop in the load leads will be compensated.
- By default maximum 1 V per load lead can be compensated.
- Via the web interface this can be set to maximum 10 V (see chapter 7).
- Note that the voltage drop in the leads decreases the max. DC output voltage rating: $U_{out-DC} = U_{leads} + U_{load}$.
- In fig. 6 - 9 it can be seen that on a 15 V power supply only 11 V will be available on the load when 2 x 2 V compensation is used.
- To minimize the inductance in the DC load leads, keep them close to each other. The inductance of these leads could give a problem with pulsating loads.
- In this case a large electrolytic capacitor (Cd) in series with a damping resistor (Rd) both in parallel with the load will help (see fig. 6 - 10). Check that the capacitor Cd in combination with the load leads and resistor Rd forms a well damped circuit.
- Since the voltmeter is internally connected to the sensing terminals, it will automatically display the voltage on the load. Note that the voltage measured on the load will be lower than on the DC power terminals of the power supply.
- The voltage limit setting should be increased by the total voltage drop in the load leads.
- For sensing on a pulsating load, see paragraph 'Special Applications' of this chapter.



fig 6 - 7
The location of the front USB-connector.

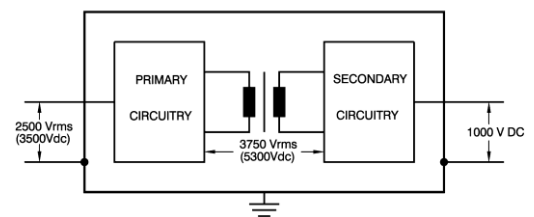

fig 6 - 8
Insulation test voltages.

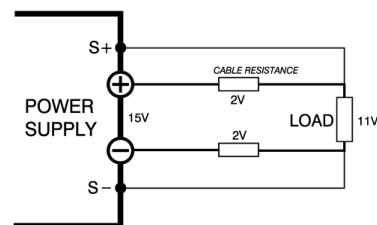

fig 6 - 9
Remote sensing: voltage drop in DC load leads subtracts from the maximum DC output voltage.

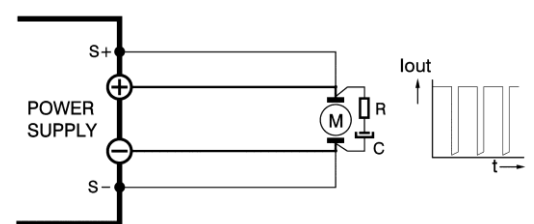

fig 6 - 10
Remote sensing on a pulsating load.

6.7 INTERLOCK FUNCTION

- The interlock connector CON F has one output (pin1) and one input (pin3). Pin2 is not used. As soon as the link between pin 1 and 3 is interrupted, the DC power output of the unit will shut down.
- If the link is open, the interlock symbol is flashing on the display, see fig. 6 - 11 and the interlock status will be active.
- Connecting the terminals will switch the DC power terminals on again.
- Warning! The terminals can only be connected to a floating contact, for example a switch or a relay. Internally the terminals are connected to a logic circuit which cannot be charged or loaded!
- The current through a closed contact is less than 1mA.
- The voltage over the open contact is 3.3V (typical).
- It is not possible to connect the interlock of multiple SM15K units in parallel.
- With regards to safety, the Interlock connector is at the level of Protective Earth.
- On optional interface ISOLATED CONTACTS, a floating interlock connector is available. See chapter of this manual.
- The maximum Interlock wiring length is 3 meters.

6.8 BI-DIRECTIONAL OPERATION

- Warning! When using the unit as a load, the user needs to take care the voltage of the source connected to the DC power terminals is not exceeding the maximum allowed voltage, a too high voltage or overshoot can damage the unit.
- Note that the inductance (like cable inductance) in series with a voltage source can cause a voltage overshoot at the DC-Power-Terminals, when switching the output from "ON" to "OFF" or switching off the mains.
- No additional hardware is needed to enable the sink current to be delivered back into the grid.
- Via the software menu the values for maximum sink current "CC-" and sink power "POWER-" can be set.
- See next paragraphs how to set up the unit for Bi-Directional operation in combination with Series or Parallel operation.

6.9 SERIES OPERATION

- The SM500-CP-90 can be connected in series without special precautions (see fig. 6 - 12).
- **Warning!** Internally there is an anti-parallel diode connected to the DC power terminals. This protects the output in case of wrong battery connection. However in series operation it can get overheated when current flows through the output with the output switched to "OFF", or the mains switched off.
- To avoid overheating of the diode, take care the output is switched to "ON" and the sink current setting CC- is sufficient to hold the current.
- The functional insulation of SM500-CP-90 allows a total series voltage of 1000V*.

**)units delivered Q4 / 2018 or newer. Older units allow a total series operation of max. 750V. Contact factory for upgrading older units to enable 1000V.*

Note the SM70-CP-450, SM210-CP-150 and SM1500-CP-30 cannot be connected in series.

6.10 PARALLEL OPERATION

- For parallel operation without the optional M/S interface, only one of the units can operate in Bi-Directional mode. Make sure the CV setting of this unit is always 0.5% higher than on the others.
- For all other units disable the Bi-Directional operation by setting the values for CC- and POWER- to 0.



fig 6 - 11
The Interlock symbol will be visible in the display when the link is interrupted.

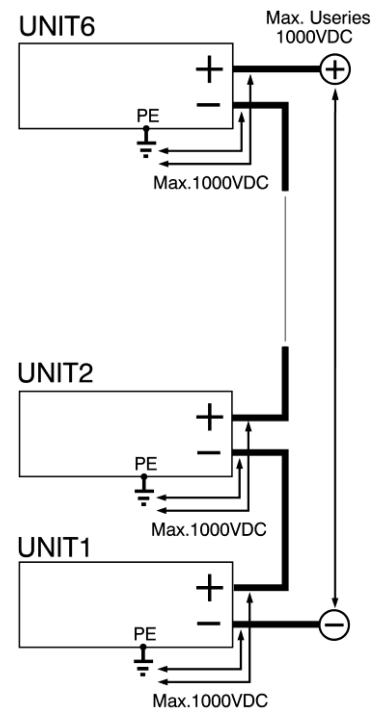

fig 6 - 12
For series operation of SM500-CP-90 the maximum series voltage is 1000VDC.

Take care the DC Power Terminals are floating and the functional insulation between DC terminals and PE is 1000VDC. This applies for both plus and minus terminals, and for all units in series.

6.11 OPTIONAL MASTER / SLAVE CONTROL

- For easy series or parallel operation, the Master / Slave interface is advised.
- See chapter 7 for more information about the M/S interface.

6.12 SPECIAL APPLICATIONS

6.12.1 PULSATING LOAD

- To avoid overheating the output capacitors, the AC component of the DC load current should be limited (see fig. 6 - 13).
- One method of reducing the AC current through the output capacitor is by using a large external electrolytic capacitor in parallel with the load. Care must be taken so that the capacitor in combination with the lead inductance will not form a series resonant circuit!
- When using remote sensing on a pulsating load (for instance a DC-motor), use a capacitor in series with a resistor over the load (see fig. 6 - 10). With this the AC-component caused by the pulsing of the load is filtered.

6.12.2 BATTERY CHARGER

- The CV / CC regulated power supplies are ideal battery chargers. Once the output is set at the correct voltage the battery will charge constantly without overcharging. This can be useful for emergency power systems.
- Use a Circuit Breaker in series in order to protect the power supply from accidental reverse connection (see fig. 6 - 14).
- The unit has a reverse diode in parallel with the output, this diode and the wiring cannot withstand the thousands of amperes supplied by a wrongly connected battery.
- Contact our support for information on which type of circuit breaker to use.

6.13 OPERATING THE UNIT

6.13.1 FIRST OPERATION

- Switch the unit ON by rotating the mains switch on the front panel clockwise.
- The first line in the front display indicates the actual values for the DC output voltage and current. See fig. 6 - 15.
- The second line shows the settings of the controls for the voltage and current. If the unit is in local operation, the text 'front' is indicated before the settings values. If the unit is set to remote programming, for example Ethernet programming, the text 'eth' is indicated. See fig. 6 - 15...19.
- The right side of the display shows the texts 'Menu', 'Lock' and 'on/OFF'. Press the push buttons right from these texts to operate the following item:
 - * Menu: This button will enter the main menu of the unit. See the next chapter for the different choices and settings.
 - * Lock: Pressing this button for about 5 seconds will lock the rotary encoders and/or the display menu. Pressing it again for about 5 seconds, will unlock the encoders and/or the display menu. This function can be useful to protect the output from accidental shutdown. See next chapter for exact possibilities of the 'Lock' function.
 - * On/Off: This button will switch the power output on or off.
- Check if the unit is in local operation: the text before the set values on the 2nd line must be 'front'. See fig. 6 - 16.
- Switch on the output by pressing the on/OFF button - it should now change to ON/off.

6.13.2 CV, CC & CP CONTROL

- Turn both the V- and A-knob a few turns clockwise.
- A voltage should now be present on the output.
- Under the values for the actual output voltage and current, the display always shows the settings for the CV-control and for the CC-control. See fig. 6 - 16.
- Depending on the load and the settings, the unit will be either in CV, CC or in CP mode. See fig. 6 - 17.
- Respectively the indication 'CV' will appear on the first line, next to the actual voltage value. The indication 'CC' will appear next to the actual current value or 'CP' will appear next to the actual power value.

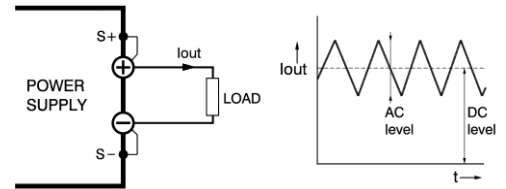

fig 6 - 13
Pulsating load current.

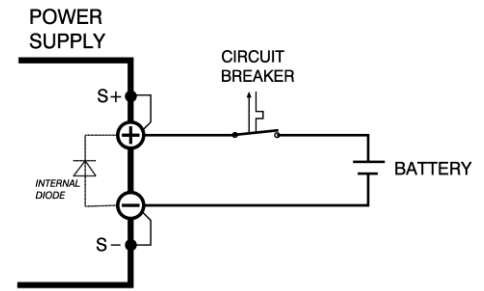

fig 6 - 14
Charging battery with a circuit breaker in series to protect the internal diode.



fig 6 - 15
The first line in the display shows the actual output value for voltage and current.

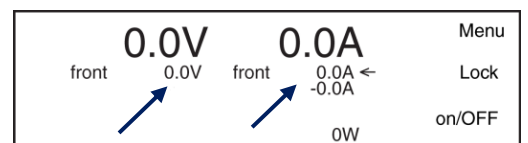

fig 6 - 16
The second line shows the set value for voltage and for source current and sink current (with a minus sign).

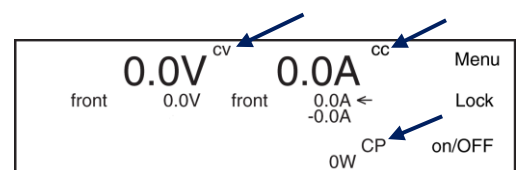

fig 6 - 17
A unit is either in CV, CC or CP mode, indicated next to the actual values of respectively the output voltage, output current or the output power.

6.13.3 CC+ & CC- SETTINGS

- By default the A-knob at the front can be used to set the CC+.
- Set the function of the A-knob via Menu > Front Settings > Knobs: here select 'Iset-' or 'Iset+'. In the display the arrow behind the value for the current changes position. See fig. 6 - 18.
- Select the options to enable sinking under special conditions via Menu > Powersink > Curr- Permissions.
- Here it can be set to sink during RSD, Interlock and Output Off.
- By pressing both the button 'Lock' followed by 'Menu' at the same time, the function of the A-knob also changes from 'Iset-' to 'Iset+'.

6.13.4 POWER+ & POWER- SETTINGS

- Set the values for maximum sink and source power via Menu > Configuration > Prg Setting > P-Settings and here rotate the V-knob to set the source power, and the A-knob to set the sink power.

6.13.5 CV, CC & CP LIMIT

- In the default configuration, the settings for CV, CC and CP Limit are set to the maximum values.
- Set the limits via Menu > Protection > Limits.

6.13.6 REMOTE PROGRAMMING

- Before the set values, the selected source is shown, see fig. 6 - 19. For example 'eth', 'web', 'seq', 'slot1' etc.
- For more information, see chapter 6 of this manual.

6.13.7 FRONT ICONS

AC FAIL

- This indicator is active if the AC input voltage is too low / too high, or if a phase is missing.

DC FAIL

- This indicator is active if the DC power terminals are 5% below or above the set value for the voltage.

OVER VOLTAGE

- This indicator is active if the voltage on the DC power terminals is 102.5% or more. The output will remain ON.

SELF PROTECT

- This indicator is active if the voltage on the DC power terminals is 105% or more. The output will switch to OFF.
- Reset by pressing the OUTPUT ON/OFF button.

OVER TEMPERATURE

- This indicator is active if the temperature measured by one of the sensors is higher than 90°C. The output will shutdown until the temperature has dropped below 80°C.

LIMITER

- This indicator is active if one of the settings for CV, CC or CP is limited.

LAN

- This indicator is active if the unit is connected to a LAN.

INTERLOCK

- This indicator is active if the terminals of the interlock connector have been interrupted.

COMMUNICATION WATCHDOG

- This indicator is active if the communication watchdog timer has expired**.

REMOTE SHUTDOWN

- This indicator is active if the DC terminals of the unit are shutdown via the ETH connection, or via an optional interface.

USB

- Not available in firmware package P0170 or older.

SMIN / SPLUS BREAK

- Not available in firmware package P0170 or older.

CV- CC OR CP-MODE

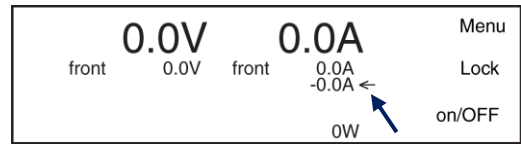

fig 6 - 18

When the arrow appears behind the negative current settings, the sink current can be adjusted with the A-knob at the front panel.

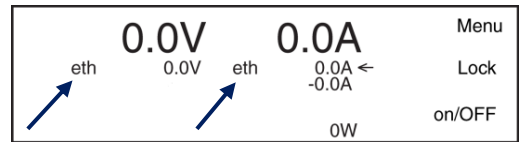

fig 6 - 19

The programming source appears before the settings. In this example both CV and CC settings are controlled via Ethernet.

	AC FAIL
	DC FAIL
OL	OVER VOLTAGE
PROT	SELF PROTECT
	OVER TEMP.
LIM	LIMITER
	LAN
	INTERLOCK
	COMM. WATCHDOG
	REMOTE SHUTDOWN
	USB
	SMIN / SPLUS BREAK

- This indicator will indicate if a unit is operating in CV, CC or CP mode.

CONTROLS LOCKED

- This indicator is active if the rotary encoders on the front panel are locked.

INTERNAL ERROR

- This indicator is active if there is an internal error in the unit, or when an interface is not correctly configured. Verify the "System information" page of the web interface. Or contact support.

INTERFACES









- This indicator is active if there is an interface build inside one of the slots at the rear side.

MASTER or SLAVE

- The standard interface icon is replaced by a Master or a Slave icon if the optional Master Slave interface is configured as a Master or a Slave.

SEQUENCER RUNNING / PAUSE / STOP

- These indicators show the status of the Sequencer.

CV CC CP	CV-, CC- OR CP-MODE
	CONTROLS LOCKED
	INTERNAL ERROR
	INTERFACES
 	MASTER OR SLAVE
  	SEQ. RUNNING / PAUSE / STOP

Note: If both the interlock and watchdog indicator conditions are true, the symbols will be displayed in an alternating way.

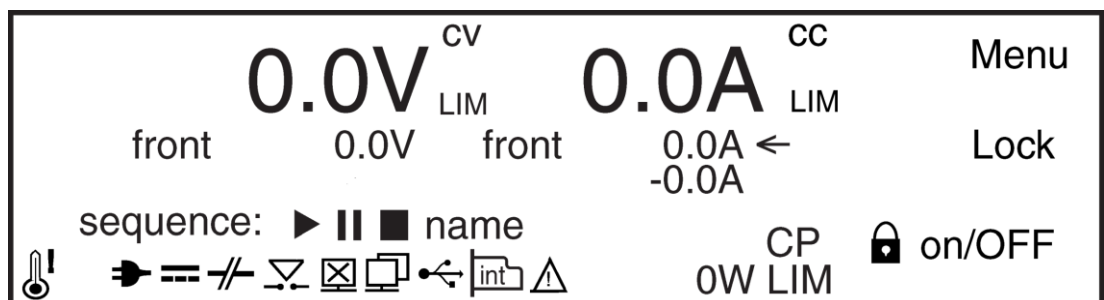

fig 6 - 20
Location of icons on the front display.

7 FRONT MENU OPERATION

7.1 ACCESSING THE MAIN MENU

- After switching on the unit, the right side of the display shows the texts 'Menu', 'Lock' and 'on/Off' (see fig. 7 - 1). Press the upper push button right from the text 'Menu' to enter the menu of the unit.
- Operate the left rotary encoder marked 'V' to choose one of the sub menus.
- To change a final setting, operate the right encoder marked 'A'.
- By using the upper or middle push buttons, one can respectively go back to the previous menu level (Back) or go deeper in the menu (Select). See below paragraphs for the possibilities.
- In every menu level, it is possible to switch the DC power output on or off, using the lower push button.

7.2 MENU MAP

- The overview in fig. 7 - 2 shows the tree structure of the main menu. Not all items are already implemented in the present firmware package. Regularly check the Delta Elektronika website for new releases. The unit can be updated with the latest package via the web interface.

7.3 MENU SETTINGS

7.3.1 SYSTEM INFO

UNIT

VERSION

- Displays the version of the firmware package.

SERIALNR

- Displays serial number

PUD

- Displays 'Protected User Data'

STATUS

TEMPERATURE

- Displays the highest temperature inside the power supply.

INPUT

- Displays mains Vac and Iac

SUPERVISOR

- In case of an error, more information about the location inside the unit is shown here.
- When there is no error, it shows 'system is okay'.

7.3.2 CONFIGURATION

FRONT SETTINGS

LCD SETTINGS

LIGHT ON

- Select the setting of the display back light level during operation of the rotary encoders or the push buttons.
- A range of 20 - 100% is available.
- The default setting is 50%.

LIGHT DIM

- Select the setting of the normal display back light level.
- A range of 0 - 100% is available.
- The default setting is 20%.

DIM DELAY

- Select the time after which the display switches back from a high level during encoder or button operation, and the normal back light level.
- A range of 0 - 200 seconds is available (0 = do not dim).
- The default setting is 5 seconds.

CONTRAST

- Select the setting of the display contrast.
- A range of 0 - 100% is available.
- The default setting is 60%.

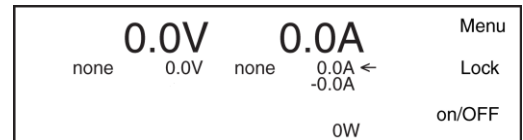

fig 7 - 1

At the right side of the display, the 3 main menu items can be chosen.

SYSTEM INFO

UNIT

VERSION
SERIALNR
PUD

STATUS

TEMPERATURE
INPUT
SUPERVISOR

CONFIGURATION

FRONT SETTINGS

LCD SETTINGS
INDICATORS
SOUNDS
LANGUAGE
KNOBS

POWER-ON STATE

VOLTAGE
CURRENT+
CURRENT-
POWER+
POWER-
OUTPUT

PRG SOURCE

V-SETTINGS
I-SETTINGS
P-SETTINGS

PRG SETTING

P-SETTINGS

POWER SINK

CURR- PREMISSION

MASTER SLAVE

STATUS
SETTINGS

SETUP

RECALL SETUP
SAVE SETUP

PROTECTION

ACCESS SECURITY

CHANGE KEY
LOCK OPTIONS
UNLOCK OPTIONS

LIMITS

VOLTAGE LIMIT
CURRENT+ LIMIT
CURRENT- LIMIT
POWER+ LIMIT
POWER- LIMIT

INTERFACES

LAN

ADDRESS
SUBNETMASK
GATEWAY
DHCP
IP-VERSION
MAC-ADDRESS

SLOTS

OVERVIEW

fig 7 - 2

Menu tree structure.

INDICATORS

- There are 13 different indicators available: OT, ACF, DCF, P-limit, Interlock, RSD, Internal error, LAN, V-limit, I-limit, USB, Sequencer and Interfaces.
- Select the setting for each indicator separately.
- Possible settings are NONE, VISUAL, AUDIO and VISUAL&AUDIO.

SOUNDS

- Select the sound for each indicator separately.
- Possible settings are 1xCHANGE, 3xCHANGE, DOWNWARDS and CONTINUOUS BEEP.

LANGUAGE

- For firmware package P0170 the language available is 'ENGLISH'.

KNOBS

- Select the function of the A-knob at the front panel, to either set the positive or negative current control.
- Possible settings are Iset+ or Iset-.
- Default setting is Iset+.

POWER-ON STATE**VOLTAGE**

- Select CV setting of the unit after mains switch on.
- Possible settings are ZERO, FIXED VALUE and RESTORE VALUE.
- Default setting is ZERO.

CURRENT+

- Select CC+ setting of the unit after mains switch on.
- Possible settings are ZERO, FIXED VALUE and RESTORE VALUE.
- Default setting is ZERO.

CURRENT-

- Select CC- setting of the unit after mains switch on.
- Possible settings are ZERO, FIXED VALUE and RESTORE VALUE.
- Default setting is ZERO.

POWER+

- Select CP+ setting of the unit after mains switch on.
- Possible settings are ZERO, FIXED VALUE and RESTORE VALUE.
- Default setting is ZERO.

POWER-

- Select CP- setting of the unit after mains switch on.
- Possible settings are ZERO, FIXED VALUE and RESTORE VALUE.
- Default setting is ZERO.

OUTPUT

- Select OUTPUT ON / OFF-setting of the unit after mains switch on.
- Possible settings are DISABLED, ENABLED and RESTORE VALUE.
- Default setting is DISABLED.

PRG SOURCE**V-SETTINGS**

- Select programming source for the CV-setting.
- Possible settings are NONE, FRONT, ETH, WEB, SEQ and SLOT1...4.
- Default setting is FRONT.

I-SETTINGS

- Select programming source for the CC-setting.
- Possible settings are NONE, FRONT, ETH, WEB, SEQ and SLOT1...4.
- Default setting is FRONT.

P-SETTINGS

- Select programming source for the CP-setting.
- Possible settings are NONE, FRONT, ETH, WEB, SEQ and SLOT1...4.
- Default setting is FRONT.

PRG SETTING

P-SETTINGS

- Change the settings for the CP-control.
- Use the V-knob to set the source power and use the A-knob to set the sink power.

POWERSINK

CURR- PERMISSION

- Select when a negative current (sink current) into the output is permitted.
- This can be set for RSD, INTERLOCK and Output OFF.
- For all options, the default setting is N.

MASTER SLAVE

STATUS

- Displays id number, configuration status and number of units
- (if device is master).

SETTINGS

- Select and view the setting for the master/slave interface.
- Selection can be done via front, via the web interface or via eth commands.
- Possible settings are master, slave or off.
- Select nr of units in parallel or in series.

SETUP

RECALL SETUP

- Recall an earlier saved setup of the menu settings, voltage and current settings and limits, network settings.
- Choose Setup1, Setup2 or Setup3.

SAVE SETUP

- Save the present settings.

7.3.3 PROTECTION

ACCESS SECURITY

CHANGE KEY

- Select the 4 digit access key.
- Default setting is '0000'.
- In case of a forgotten access key see troubleshooting (chapter)

LOCK OPTIONS

- Select which functions are blocked with the 'LOCK' function.
- Possible settings are 'Menu' and 'Menu & Controls'.
- Default setting is 'Menu & Controls'.

UNLOCK OPTIONS

- Select how to unlock the unit. To make a selection, first the 4-digit access key must be entered.
- Possible settings are 'With Key' and 'Without Key'.
- Default setting is 'Without Key'.

LIMITS

VOLTAGE LIMIT

- Select the setting for the Voltage limit.
- Possible settings are 'DISABLED' and 'FIXED VALUE'.
- Default setting is 'DISABLED'.

CURRENT+ LIMIT

- Select the setting for the Current+ limit.
- Possible settings are 'DISABLED' and 'FIXED VALUE'.
- Default setting is 'DISABLED'.

CURRENT- LIMIT

- Select the setting for the Current- limit.
- Possible settings are 'DISABLED' and 'FIXED VALUE'.
- Default setting is 'DISABLED'.

POWER+ LIMIT

- Select the setting for the Power+ limit.
- Possible settings are 'DISABLED' and 'FIXED VALUE'.
- Default setting is 'DISABLED'.

POWER- LIMIT

- Select the setting for the Power- limit.
- Possible settings are 'DISABLED' and 'FIXED VALUE'.
- Default setting is 'DISABLED'.

7.3.4 INTERFACES

LAN

ADDRESS

- Select / View the present IP-address.
- The default setting is 169.254.0.2.

SUBNETMASK

- Select / View the present Subnet-mask.
- The default setting is 255.255.0.0.

GATEWAY

- Select / View the present Gateway-address.
- The default setting is 169.254.0.1.

DHCP

- Select the setting for DHCP.
- Possible settings are 'Enabled' and 'Disabled'.
- Default settings is 'Enabled'.

IP-VERSION

- View the IP-version.
- For firmware package P0170, this version is V4.

MAC ADDRESS

- View the unique MAC-address.
- The address is in the range of F4:E1:42:xx:xx:xx.

SLOTS

OVERVIEW

- Shows the optional installed interfaces in Slot1, 2, 3 and 4.

7.4 FIRMWARE UPDATING

- Check the version of the firmware in the unit via Menu > System Info > Unit > Version.
- Go to and check if there is new firmware available via Products -> SM15K -> Downloads.
- Download the new firmware package to the computer.
- Connect the unit to the above computer via LAN and open the SM15K web interface using an internet browser.
- The web interface is found by entering the IP-address of the unit in the address bar of the browser. The IP-address is found via Menu > Interfaces > LAN > Address.
- Note: when DHCP is enabled the IP-address can change, for example after a power cycle.



fig 7 - 3 - Via the web interface the downloaded firmware package can be uploaded to the unit.

- In the web interface, go to Administration -> Firmware.
- Select "Choose File" and browse to the downloaded package, enter password and "Start Update". See below figure 7 - 3 for a screen shot of the web interface.
- Recommended firmware package is P0170.

7.5 AUTO-SYNCHRONIZE

- During power-up, the power supply will check for interface modules. Once in contact, the firmware version is checked to verify if it is compatible with the unit. If so, nothing is noticed of this process.
- But if there is a mismatch, the interface module and the unit will not function properly together.
- Therefore the user is prompted in three different ways: via the front panel, via Ethernet commands and via the web interface.

7.5.1 VIA FRONT PANEL

- The front display will show a warning "Interface firmware incompatible with unit. Auto-synchronize?".
- There are two options: "cancel" and "OK".
- "Cancel" allows proceeding to the normal operation, but with the possibility that the unit and interface module don't work properly. The message "Update required" will be shown.
- Selecting "OK" will activate an update mechanism, and the firmware of the interface module is updated to a matching version. No network connection is required, and no update file has to be applied since the power supply itself contains the matching firmware version of each type of interface module.

7.5.2 VIA ETHERNET COMMAND

- To query the need of auto-synchronization, the "SYSTEM:WARNING?" command can be sent.
- See the manual "Ethernet + Sequencer".
- Via Ethernet commands there is no possibility to start the auto-synchronization.

7.5.3 VIA WEB INTERFACE

- Go to "Administration, Info". A warning is shown in case of a firmware version mismatch.
- The mismatching interface module can be auto-synchronized by going to the related slot in "Configuration, Interfaces". Select "Auto synchronize" and "Apply settings" and the update mechanism will be activated.

8 REMOTE PROGRAMMING

8.1 SOURCE SETTINGS

- Via the front menu, the source can be set to the required programming input via: Menu -> Configuration -> Source.
- The possible settings for V-settings, I-settings and P-settings are front encoders, ethernet, web interface, sequencer or an optional interface in rear slot1, 2, 3 or 4.
- It is possible to have different sources for the settings for example V- and I-settings via 'web' and P-settings via 'front'.

8.2 WEB INTERFACE

- It is advised to use the web browsers Mozilla Firefox, Google Chrome or MS Edge.
- The web interface is available 15 seconds after startup of the unit.
- Set the programming source for voltage, current and/or power to 'web' via the front menu.
- The below menu items are available in the web interface:

8.2.1 CONSOLE

FRONTPANEL

- Possible settings via the console:
 - voltage, current and power
 - output On/Off
- Possible monitoring via the console:
 - actual and set values of voltage, current and power
 - output setting (on/off)
 - status icons, for example DC-fail
 - type of unit and serial number
 - on time of the unit
 - system temperature and fan speed
 - input voltage
- See fig. 8 - 1 for the console lay-out.

SEQUENCER

- Possible to select sequences from the unit memory.
- Running, Pausing and Stopping of sequences.
- Trigger sequence
- Running in Single Step mode.
- Monitor sequencer variables and timers via the "advanced" button.
- See fig 8 - 2 for the console lay-out.

MASTER / SLAVE

- Only available on the Master unit.
- Overview of the entire system.
- Shows the most important icons.
- Links to the front panels of Slave units when the Slave(s) are connected to the same LAN. (Click ID#)
- See fig 8 - 3 for the console lay-out.

8.2.2 CONFIGURATION

GENERAL

FRONTPANEL

- Front user interface language.
- Front unlock key protected (Enabling will lock Frontpanel).
- Backlight intensity when active.
- Backlight intensity when no user interaction.
- Timeout for backlight dimmer.
- LCD contrast.

DEFAULTS

- Default voltage setting and value after power cycle.
- Default current+ and current- setting after power cycle.
- Default power+ and power- setting after power cycle.
- Default output state after power cycle.



fig 8 - 1
Front console for setting of the output and monitoring various parameters.



fig 8 - 2
Sequencer console for selecting and controlling sequences.



fig 8 - 3
Console for Master / Slave monitoring..

LIMITS

- Switch Voltage Limit ON or OFF and set value.
- Switch Current Limits ON or OFF and set values.
- Switch Power Limits ON or OFF and set values.

SOURCES

- Set the program source for voltage control.
- Set the program source for current control.
- Set the program source for power control.

POWER SINK

- Sink current when Remote ShutDown is activated.
- Sink current when Interlock link is open.
- Sink current when the Output is Off.

NETWORK

- DHCP enabled / disabled.
- IP Version.
- Network IP address.
- Network Subnet mask.
- Network Gateway address.
- Network interface MAC address.

INTERFACES (Slot1, 2, 3 and 4)**ISOLATED ANALOG**

- Voltage levels on analog programming and monitoring for output voltage and current.
- Level of Status signals ACF, DCF, LIMIT, RSD, OT, CC.

SERIAL & USB

- Select BUS-type: USB, Differential, RS232.
- Device channel nr.
- Baudrate, Databits, Stopbits, Parity bits.
- Slewrate, Termination, Simplex/Duplex.

DIGITAL I/O

- Level of digital inputs A...H (High / Low).
- Level of digital outputs A...H (High / Low).

ISOLATED CONTACTS

- Status of the relay contact 1...4 (On / Off).
- Level of the Interlock input (High / Low).
- Level of the Enable input (High / Low).

MASTER / SLAVE

- Enable or disable master / slave mode.
- Select Master or Slave.
- Number of units in parallel or series.

SEQUENCES

- Upload sequences into the unit's volatile memory.
- Synchronize memory to copy sequences from the volatile to the non-volatile memory.
- After switching off the unit, the sequences remain on the power supply.
- Monitor and make settings:
 - View sequencer name
 - View if it is loaded as active sequencer
 - View if it has been built
 - Mark for Non-Volatile
 - Set start/stop conditions
 - Set if to restore or retain output state and values after it is terminated
 - Mark for deletion
- See paragraph 4 of this chapter for more information about sequencer programming.

REGULATION**MISCELLANEOUS**

- Restore Regulation defaults – NEW.

VSENSE_CONTROL

- Cable compensation by Proportional, Integral and Derivative settings.
- Set Upper_Limit and Lower_Limit.

V_CONTROL

- Load compensation by Control Speed setting.

FUNCTION BLOCKS

- Select which type of Function Block to use:
 - Internal Resistance
 - Leadless Sensing
 - Photovoltaic Simulation
- Make the settings for the parameters and select its programming sources.
- Configure the power supply program sources to use the function block as program source for its output controllers.
- See Function Blocks Manual for more information and examples on our website.

8.2.3 ADMINISTRATION

FIRMWARE

- Here a new firmware package can be uploaded.

INFO

- System information
 - Unit.
 - Serial number.
 - Manufacturer.
 - Software version.
 - Internal error.
- Highlight button
 - Display on front will blink for about 2 seconds.
 - Buzzer on front is on for about 2 seconds.

LOGGING

- Ethernet communication
 - Download log file.
 - Log settings displayed.

PASSWORD

- Change the password to block the unit.
- The default password is "depower".
- Passwords are not case sensitive.
- In case of a forgotten password see next chapter Trouble Shooting.

8.2.4 DOCUMENTATION

- Unit documentation in PDF-format available:
 - Safety instructions.
 - Unit operation and installation manual.
 - Interfaces operation and installation manual.
 - Ethernet & Sequencer programming manual.

8.3 ETHERNET

- The ETH interface is available 15s after startup of the unit.
- Connect the unit to the network via the LAN-connector at the rear side, see fig 8 - 4.
- Download the programming manual for Ethernet & Sequencer via the web interface or via .
- Set the programming source for voltage, current and/or power to 'eth' via the front menu or the web interface.

8.4 SEQUENCER

- Download the programming manual for Ethernet & Sequencer via the web interface or via .
- Define a sequence using a basic text editor, for example Notepad. Save as "filename.seq". An example is shown in fig. 8 - 5 and fig. 8 - 6.
- Upload the sequence to the unit via the web interface or via Eth programming commands.
- Set the programming source for voltage, current and/or power to 'seq' via the front menu, the web interface or Eth commands.
- Start/Stop the sequence via the web interface, Eth commands or a hardware trigger via the Digital I/O interface.
- **Note:** copy the uploaded sequences into the non-volatile memory before switching off the unit. Standard they are uploaded in the volatile memory and are lost after switching off the mains.



fig 8 - 4

The location of the LAN-connector and the available interface slots at the rear panel.

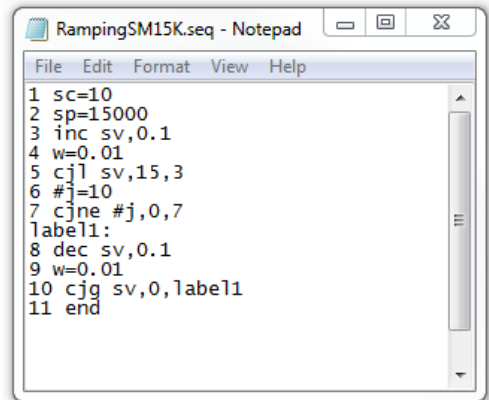

fig 8 - 5

Example of a small sequence to ramp up the output to 15V and then back to 0V.

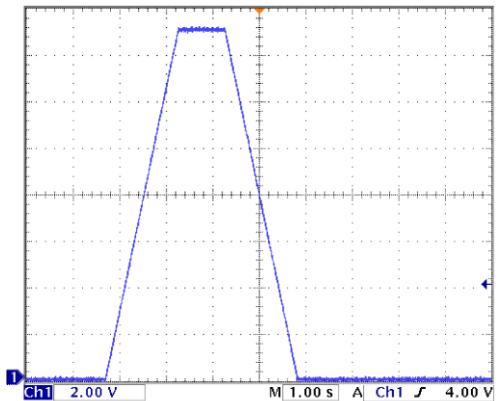

fig 8 - 6

Output voltage as result of the above example..



fig 8 - 7

Serial & USB Programming Module.

8.5 OPTIONAL INTERFACES

- Set the programming source for voltage and/or current to 'slot1...4' via the front menu, the web interface or Eth commands.
- The following interfaces can be plugged in the slots at the rear panel of the unit. There is room to insert a total of 4 interfaces (see fig. 8 - 7 ... 11).

8.5.1 SERIAL & USB PROGRAMMING

- The protocols RS232, RS422, RS485 and USB (Virtual COM) are supported by this interface.
- With this interface it is possible to program the CV- and CC-settings, to read the CV- and CC-monitor values and the internal status signals.
- See datasheet and manual of the INT MOD SER for more information.
- Maximum 4pcs of this type of interface per unit.

8.5.2 DIGITAL I/O

- This interface provides 8 opto-isolated logic inputs and 8 opto-isolated logic open drain outputs.
- All in- and outputs have a common zero.
- Also see datasheet and manual of the INT MOD DIG.
- Maximum 4pcs of this type of interface per unit.

8.5.3 ISOLATED CONTACTS

- On this interface, there are 4 floating relay contacts available that can be controlled by Ethernet commands.
- This can be used to trigger an external safety alarm or to interact in automated processes.
- Floating Interlock connector (standard Interlock is at the level of Safety Earth).
- Floating Enable input to switch the output On/Off (24Vdc).
- See datasheet and manual of the INT MOD CON for more information.
- Note: the floating relay contacts cannot be controlled by the sequencer.
- Maximum 4pcs of this type of interface per unit.

8.5.4 MASTER / SLAVE CONTROL

- The resulting combination behaves like one power supply and can be manually controlled or programmed on the master.
- Mixed parallel - series operation is not possible.
- **Note1:** max 1pcs M/S-2 interface possible per unit.
- **Note2:** the M/S-2 interface is for SM15K-units only, the M/S interface is for SM3K3 units only.
- Also see datasheet and manual of the IND MOD M/S-2.

8.5.5 ISOLATED ANALOG PROGRAMMING

- With this interface it is possible to program the CV- and CC-settings using a 0 - 5V or 0 - 10V voltage source.
- The CV- and CC-monitor signals can be measured with a volt meter (0 - 5V or 0 - 10V). Also available are the 5V logic status signals, Remote ShutDown (RSD = 5V), an auxiliary voltage (+12V) and a reference of 5.1V.
- Because the interface is isolated from the power output, earth loops between the programming source and the power supply are prevented.
- All connections are pin compatible with other Delta Elektronika power supplies such as ES150, SM3300, SM800, SM1500, SM6000 etc.
- Note: maximum 1 analog interface possible per unit.
- Also see datasheet and manual of the INT MOD ANA.



fig 8- 8
Digital I/O Module.



fig 8 - 9
Isolated Contacts



fig 8 - 10
Master Slave interface M/S-2.
Note: the M/S-2 can only be used in SM15K



fig 8 - 11
Isolated Analog interface

9 TROUBLE SHOOTING

9.1 GENERAL

- If you have a question about the unit, please contact our engineers using the address Support@Delta-Elektronika.nl.
- In case the unit is defect, please first fill out the RMA-form before sending the unit to us. Adding a detailed fault description will help us to repair the unit as soon as possible. Do not try to repair the unit yourself.
- On our website the RMA-form can be found under 'Support'.

9.2 NO DC OUTPUT

- If 'OL' or 'PROT' is displayed, see paragraph 8.9 in this chapter. **Warning!** Risk of damage by over voltage.
- Check the output is switched ON: the text 'ON/off' must be visible on the right side of the display.
- If the text is 'on/OFF', press the button next to this text to switch it ON if needed.
- Check the unit is not in LOCK mode: the text 'Lock' must be visible on the right side of the display.
- If the text is 'Unlock', press the button next to this text for a few seconds to unlock the unit, see fig. 9 - 1.
- First set the unit in local operation (or so-called manual operation): press and hold the ON/off button for 4 seconds.
- On the second line of the display, before both the set values the text 'front' will be seen, now press the button next to the text on/OFF to switch on the output.
- Check connections on the SENSE BLOCK (at rear panel).
- For local sensing, there should be a link between + and S+ and between - and S- (see fig. 9 - 2).
- For remote sensing, the wires from S+ and S- should be connected to respectively the + and - terminals on the load.
- Check there is a link between pin 1 and pin 3 of the Interlock connector.
- Check the settings for CV- CC- and CP-limit are set to a value greater than 0.
- Go to Menu -> Protection -> Limits.
- Here set Voltage, Current and Power limits.
- Turn both the CV and CC encoders a few turns clockwise, and via Menu > Configuration > Prg Setting > P-Settings set a value suitable to the required power.
- Now a voltage should be present on the output.

9.3 PROGRAMMING DOES NOT WORK OK

- First make sure the unit works okay in local mode, see previous paragraph.
- If this is okay, check the unit is in Remote mode.
- Go to Menu -> Configuration -> PrgSource.
- Here set the Vsettings, Isettings and Psettings to the required programming source, either 'eth', 'web', 'slot1', 'slot2', 'slot3' or 'slot4'.
- For example, when programming via Ethernet, on the second line of the display, before both the set values the text 'eth' must be seen (see fig. 9 - 3).
- It is also possible to only have one of the settings in remote mode, and have the other setting in local mode.
- Enter a command to program the Vsettings, Isettings and Psettings to a value greater than 0.
- Now a voltage should be present on the DC output.
- Note: when changing programming source, the output switches to OFF (to avoid accidental damage to a load).
- If the text is 'on/OFF', press the button next to this text to switch it ON if needed.

9.4 PARALLEL PROBLEMS

- Check the voltage drop of the DC wiring between the master and the slaves is < 10 mV.
- Check the wiring has a low inductance.
- Without a M/S-interface, check that one of the units operates in Bi-Directional mode. And check the CV setting of this unit is always 0.5% higher than on the slaves.

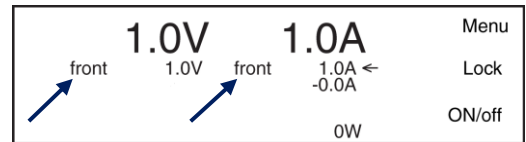

fig 9 - 1

At the right side, the texts must be 'Lock' and 'ON/off'.



fig 9 - 2

For normal operation links should be connected between S+ and +, and between S- and -. Note that there is room for two links in each sense block but it is sufficient if one is connected.

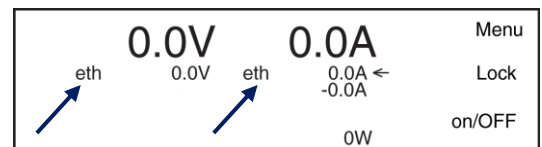

fig 9 - 3

For Ethernet programming, the text 'eth' must be seen before the setting(s) that is/are in 'remote mode'.

- For all other units check the CC- and POWER- is set to 0.

9.5 DC VOLTAGE IS HIGHER THAN SET VALUE

- Check connections on SENSE BLOCK (on rear panel), For normal operation there should be a link between + and S+ and between – and S– (see also fig. 9 - 2).
- When remote sensing is used, check the wires of the sensing.
- Check that if the connected load does deliver power back into the unit, the power supply is set in Bi-Directional mode. See also paragraph 8.9 on this page.

9.6 OT indicator blinks

- The temperature of one of the internal heat sinks or modules is too high, the output has been shutdown to avoid overheating (see fig. 9 - 4).
- Check if the cooling fans are running.
- Check if the air temperature of the air inlets (at the left side) is below 50 °C and the airflow is not obstructed.

9.7 ACF indicator on

- The AC mains voltage is too low or too high or was intermittent because of a bad connection. Disconnect the mains, wait a few minutes and try again (see fig. 9 - 5).
- There is a phase missing from the mains supply.
- If the AC mains voltage is within the specified range, there must be an internal error. Send the unit for repair, see paragraph 1 of this chapter.

9.8 DCF indicator on

- The DC output voltage is 5% below/above the set voltage. This automatically happens when the unit is in CC-mode and can happen when the unit is in CP-mode (see fig. 9 - 6).
- If the DC output voltage is within 5% of the set value, there must be an internal error. Send the unit for repair, see paragraph 1 of this chapter.

9.9 OL or PROT indicator on

- If the text OL or PROT appears in the display, the output voltage on the DC power terminals is respectively 2.5% or 5% above the nominal voltage. E.g. for an SM500-CP-90, the nominal voltage is 500V.
- The OL-indicator is a warning for voltage Overload.
- The PROT indicator will also switch off the DC output terminals (Self-Protection mode).
- **Warning!** Risk of damage by over voltage. First remove the high external voltage from the DC terminals, before resetting the output.
- Reset by pressing the OUTPUT ON/OFF button.

9.10 Internal Error indicator on

- This indicator is active if there is an internal error in the unit, or when an interface is not correctly configured. Verify the "System information" page of the web interface or front menu (see fig. 9 - 7).
- Either the unit or one of the interfaces has to be send for repair.

9.11 Forgotten password, access key or network settings

- To reset the front panel access key, the password and the network settings to their default values, press the reset button at the rear panel of the unit (while the unit is switched on).
- A bent paperclip can be used to press the internal micro push button (see fig. 9 - 8).
- A soft sensible click can be noticed. Press and hold the button for at least 4 seconds in order to activate the default restoring mechanism.

9.12 Other

- If the problem is not described in the above paragraphs, please see paragraph 1 of this chapter on how to contact our support department or send the unit for repair.



fig 9 - 4

If the OT-icon is shown on the display, the unit has run hot and the DC power terminals are shut down.



fig 9 - 5

If the ACF-icon is shown on the display, the unit has not enough AC input power and the DC power terminals are shut down.



fig 9 - 6

If the DCF-icon is shown on the display, the voltage at the DC power terminals is 5% below/above the set voltage.



fig 9 - 7

If the Internal Error-icon is shown on the display, the DC-power output of the unit will shunt down.



fig 9 - 8

Location of the reset button.

10 MAINTENANCE & CALIBRATION

10.1 GENERAL

- The SM-series power supplies do not need any maintenance or calibration. However, care must be taken that the cooling unit is not obstructed.

10.2 COOLING FAN

- The internal construction of the power supply is such that no dust will reach the sensitive control circuitry, the heat sinks in a tunnel will be cooled by forced air (see fig. 10 - 1)
- The built up of dust on the impeller of the fan and the heat sink fins depends on the environment. It is advised to inspect the fans and heat sinks regularly.
- Since the used fan type has an over-capacity, dust will not present a problem very quickly.
- The thermal protection will shut down the output in case of overheating, so no damage will be done to the power supply.

10.3 GALVANIC INDUSTRY

- For using the power supplies in the galvanic industry, it is strongly recommended to take precautions against an aggressive environment.
- An aggressive environment with acid, salt, etc. can harm the electronic components. Sometimes even the copper tracks on the printed circuit boards dissolve.
- To avoid problems, the power supplies should be mounted in a relatively clean room, in a cabinet receiving clean air with over pressure, or a cabinet with a heat exchanger.

10.4 CALIBRATION

- The power supplies are factory calibrated and normally need no further calibration.
- After installation of a new or different interface, no calibration is needed.
- Only in special situations, for example after repairing a unit, calibration can be necessary.
- The SM15K units can only be calibrated by software.
- Inside the unit, there are no positions with calibration components such as trimmers or CR-resistors.
- The software calibration is performed by connecting the unit to a TCP/IP network using the LAN connector at the rear panel.
- Download the programming manual for Ethernet & Sequencer via the web interface or via www.delta-elektronika.nl.

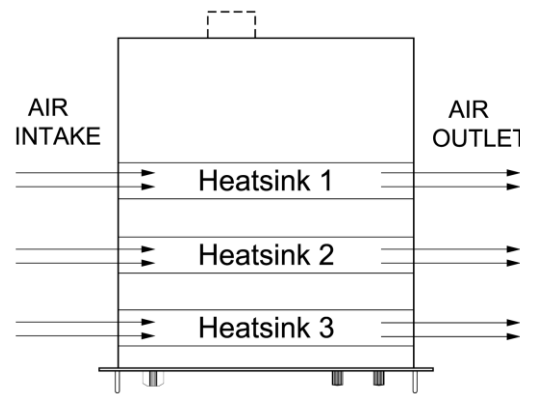

fig 10 - 1

The fans are located at the left side and blow through the tunnel.



11 EU Declaration of Conformity - SM15K-series



We

Delta Elektronika
Vissersdijk 4
4301 ND ZIERIKZEE
The Netherlands

Declare under sole responsibility that the following Power Supplies:

SM70-CP-450
SM210-CP-150
SM500-CP-90
SM1500-CP-30

Meet the intent of Directives

2014/30/EU Electromagnetic Compatibility (EMC)
2014/35/EU Low Voltage Directive (LVD)
2011/65/EU Reduction of Hazardous Substances (RoHS2)

Compliance was demonstrated to the following specification as listed in the official Journal of the European Communities:

EN 61326-1:2013 EMC requirements for electrical equipment for measurement, control and laboratory use

EN 61010-1:2010 Safety requirements for electrical equipment for measurement, control and laboratory use

EN IEC 63000:2018 Assessment of electrical and electronic products with respect to RoHS

J. Koopman
Managing director,
Zierikzee, April 2024