



SM15K - Function Blocks

- **LEADLESS SENSING**
- **INTERNAL RESISTANCE**
- **PHOTOVOLTAIC SIMULATION**

Firmware Update

It is strongly recommended, first to perform a firmware update before further operation. Download the SM15K Quick Start Manual for instructions.

Driver & Example Software

For several applications and Interfaces there is Driver & Example Software available on our website. See [PRODUCTS\SM15K\DOWNLOADS](#).

APPLICATION NOTE

Firmware version P0140

Contents:

- 1 – [General information](#)
- 2 – [Leadless Sensing](#)
- 3 – [Internal Resistance](#)
- 4 – [PhotoVoltaic Simulation](#)

1 General Information

1.1 Function blocks.

With the new SM15K series Delta introduces “Integrated Function Blocks”. Integrated Function Blocks are functional integrated software blocks with predefined behavior that can be put in between a program source and the units output controllers. By using these Integrated Function Blocks the user is able to manipulate the units Program sources or can setup specific simulations.

The program sources for the function blocks are freely selectable. The output of an active function block is made available in its output register. The function output register can be selected as a program source for the output control.

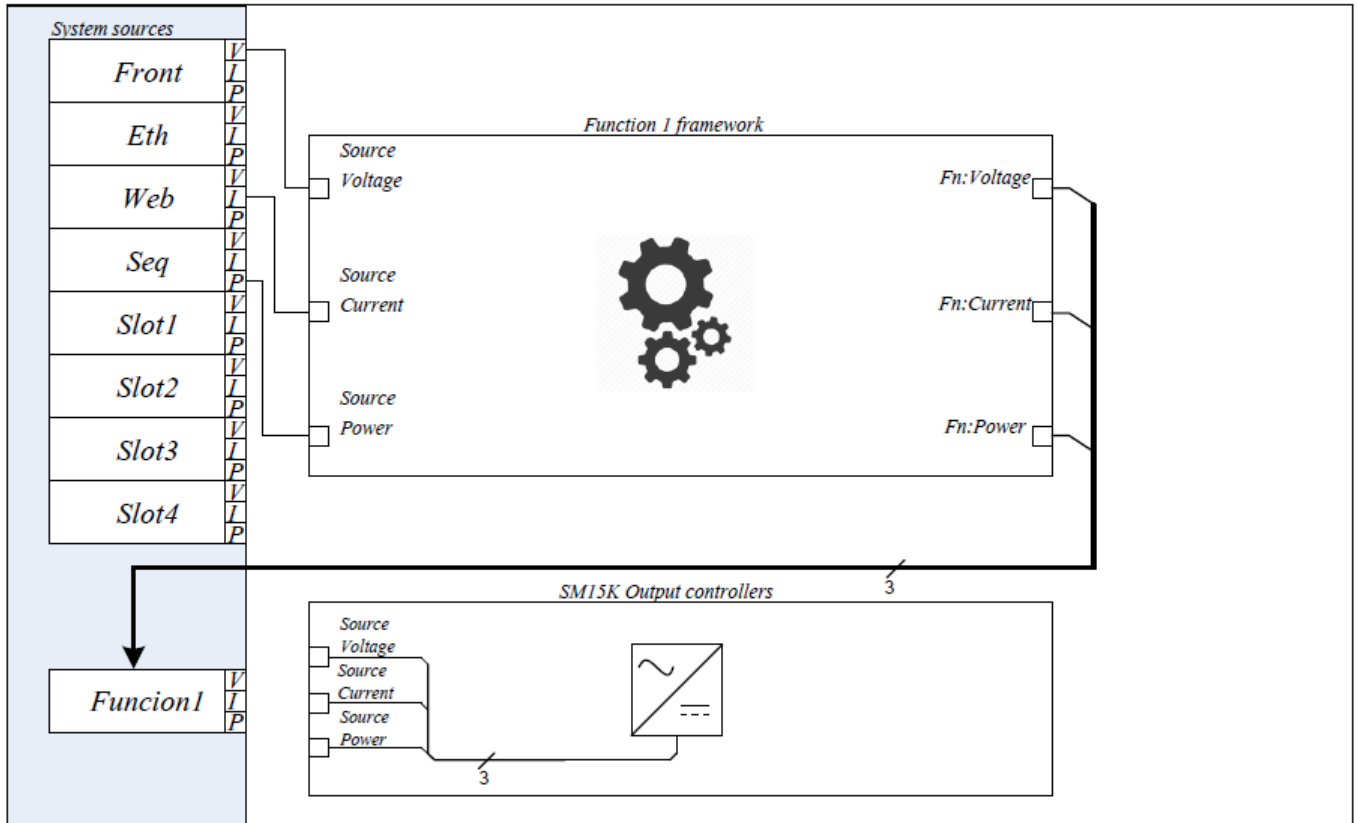

1.2 Configuration

The configuration of a function block can be done through the units web interface (Configuration->Functions) and through the ethernet interface using the SCPI commands. Enabling and configuring a function block:

- 1) Enable a function block by selecting a Function type, for example “Internal Resistance”.
- 2) Configure the function block parameters and select its program sources (Voltage, Current, Power).
- 3) Configure the power supply program sources to use the function block as program source for its output controllers.

2 Leadless Sensing

2.1 Function description

The Integrated Function Block “Leadless sensing” is a functional integrated software block with predefined behavior that can be put in between a program source and the units output controllers. By using this Integrated Function Block the user is able to compensate a voltage drop falling over long or high resistive load cables.

The Voltage program source for this function block is freely selectable; however the Power and Current sources are fixed to “None” (zero). The compensated sources of the active function block are always written in program source “Function 1” where it’s again available as a regular program source.

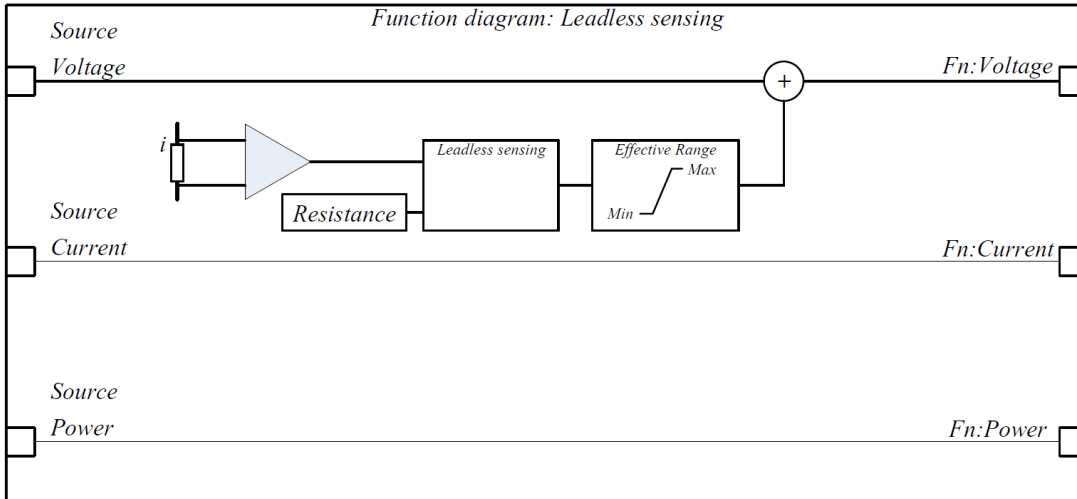

2.2 Usage Example

- 1) User selects through the Web-interface (Configuration->Functions) the Function type “Leadless sensing” (+Apply function type).
- 2) Configures the (cable) resistance as 2 ohm, and limits the compensation range to +100V and -100V.
- 3) Selects “Front” as Voltage program source.
- 4) User selects through the Web-interface (Configuration->General) the Voltage controller source “Function 1”.
- 5) User configures the power and current controller sources properly.

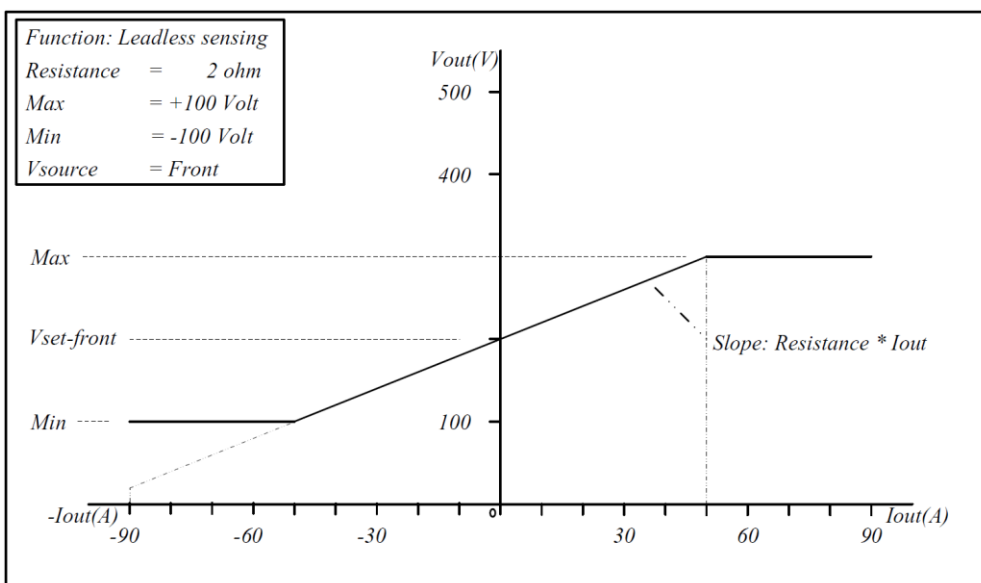

3 Internal Resistance

3.1 Function description

The Integrated Function Block “Internal Resistance” is a functional integrated software block with predefined behavior that can be put in between a program source and the units output controllers. By using this Integrated Function Block the user is able to simulate a voltage drop falling over a virtual internal resistance.

The Voltage program source for this function block is freely selectable; however the Power and Current sources are fixed to “None” (zero). The compensated sources of the active function block are always written in program source “Function 1” where it’s again available as a regular program source.

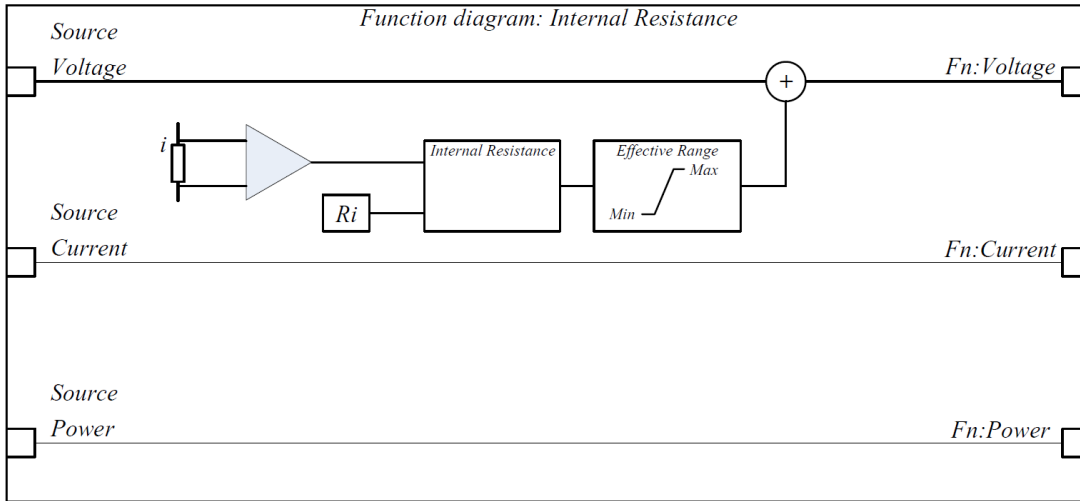

3.2 Usage example

- 1) User selects through the Web-interface (Configuration->Functions) the Function type “Internal resistance” (+Apply function type).
- 2) Configures the virtual resistance as 2 ohm, and limits the compensation range to +100V and -100V.
- 3) Selects “Front” as Voltage program source.
- 4) User selects through the Web-interface (Configuration->General) the Voltage controller source “Function 1”.
- 5) User configures the power and current controller sources properly.

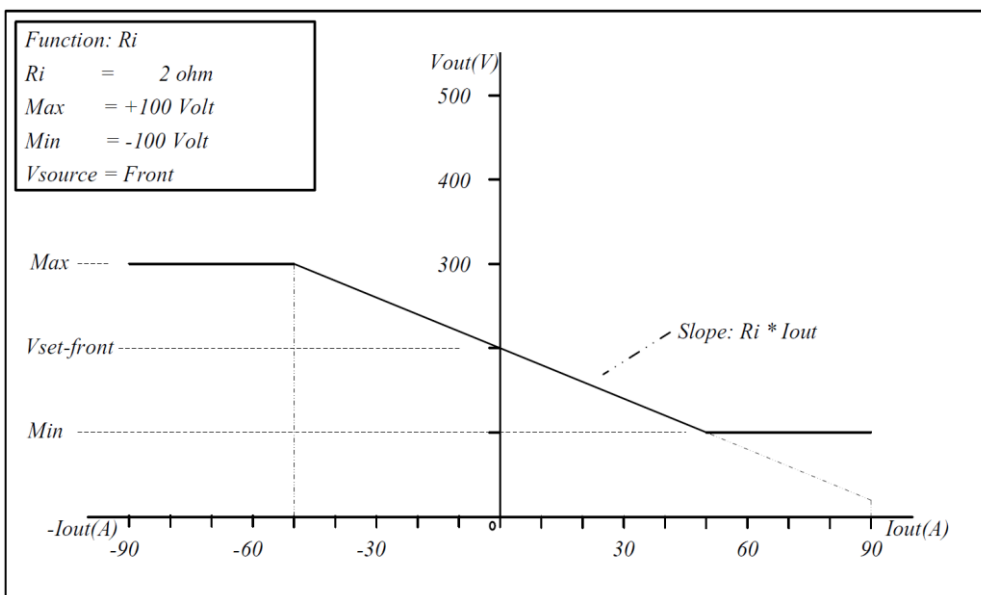

Resistance Ranges:

SM70-CP-450:

0.001...0.33Ω.

SM210-CP-150:

0.001...1.0Ω.

SM500-CP-90:

0.001...10Ω.

SM1500-CP-30:

0.001...10Ω.

* smallest step size 1mΩ.

4 Photovoltaic Simulation

4.1 Function description

The Integrated Function Block “photovoltaic” (or PV) is a functional integrated software block that can be configured to program the units output controllers. By using the “photovoltaic” function block users are able to simulate a full scale solar plant. Panel specifications, temperature and irradiance can be configured statically through the web interface and updated dynamically by using the SCPI interface when used in automated processes.

There are no programmable sources for this function block. The outputs of the active function block are always written in program source “Function 1” where it’s again available as a regular program source.

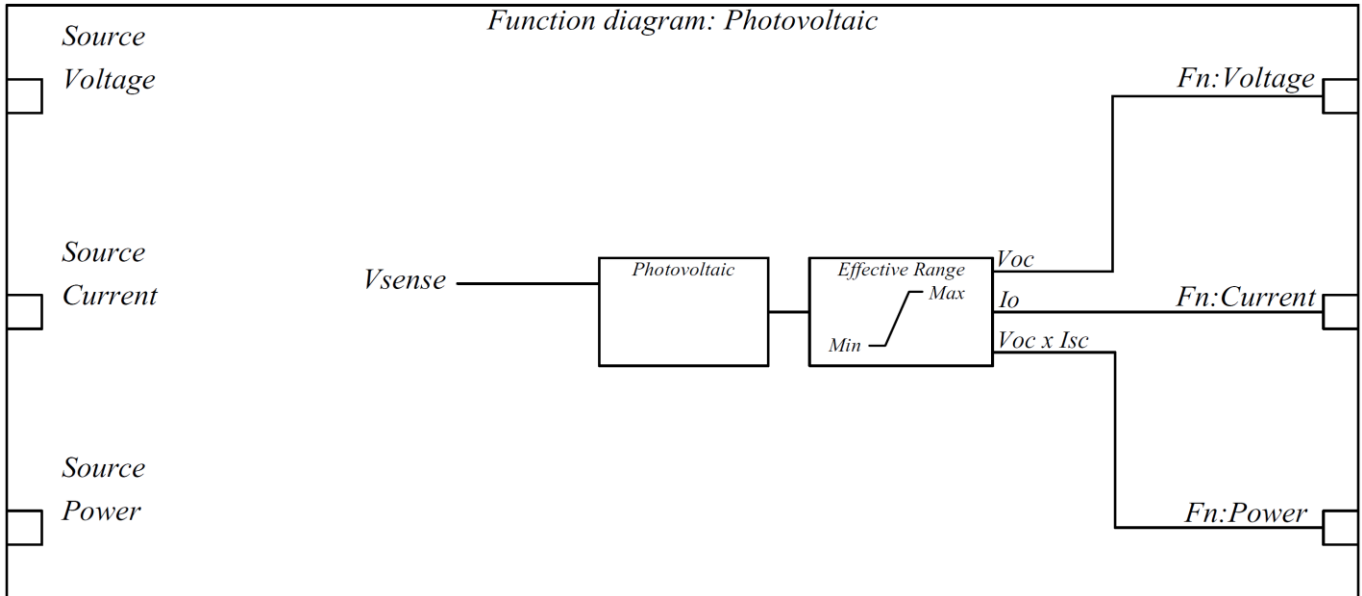

4.2 Usage example

- 1) User selects through the Web-interface (Configuration->Functions) the Function type “Photovoltaic Simulation” (+Apply function type).
- 2) User configures the Photovoltaic plant specifications.
- 3) User selects through the Web-interface (Configuration->General) all controller sources to “Function 1”.
- 4) User verifies the PV curve through the web interface simulation console (Console->Simulation).

Note1: Changes through SCPI will directly be updated in the simulation console.

Note2: Changes in Photovoltaic configuration will force the output to OFF unless ‘Direct mode’ is enabled.

